

# Pico Naglee Tract – RD 1007 Emergency Operations Plan Basic Plan

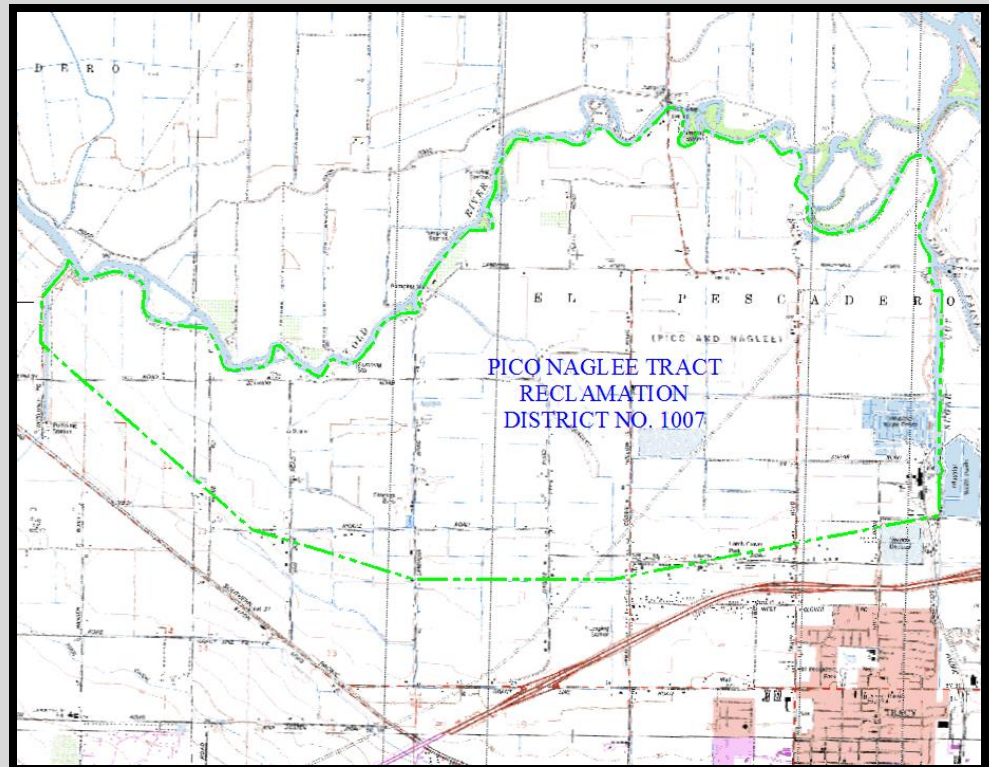
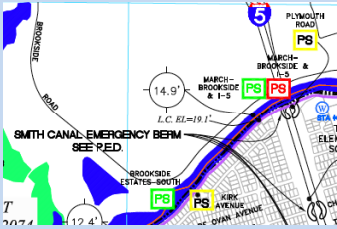

Special District EOP-Basic Plan  
San Joaquin Operational Area

April 2016

# Disclaimer

“This Emergency Operations Plan (“Plan”) is intended to be a set of guidelines to be followed in the event of a flood emergency. Emergency conditions may vary significantly, and may require that different elements of the Plan be utilized depending upon the nature and extent of the particular emergency event, despite language in the plan that appears to mandate certain actions. Notwithstanding anything to the contrary set forth in the Plan, including any language that appears to require particular action(s), the District preserves the ability to undertake all or any portion of the Plan as necessary and appropriate to respond to the particular emergency and preserve life and property. Under no circumstances will the District Board or its officers or employees be personally responsible for the procedures undertaken or not undertaken by Reclamation District No. 1007 in the event of a flood emergency, regardless of whether such procedures were or were not included in the Plan.”

# Plan Promulgation

To whom it may concern:

This document and accompanying annex map, having been duly reviewed and approved by the Board of Trustees of Reclamation District No. 1007, is hereby promulgated as the official emergency plan of the District. District staff are directed to use this plan as the basis for emergency response to flood events. This plan meets the safety plan requirements of Section 9650 of the California Water Code and is compliant with the National Incident Management System (NIMS) and the National Response Framework.

The District Engineer is hereby directed to distribute this plan to outside agencies in accordance with the Record of Initial Distribution to ensure proper inter-agency coordination during emergency operations. Copies of the plan shall be provided to additional agencies upon request.

The Board of Trustees shall review this plan and accompanying annex every third annual meeting or after each major levee modification during the completion of the community for needed changes and updates. The Board President is authorized to make routine updates and changes to the plan as required by changes in district operations and personnel and changes to outside agency plans that affect district operations.

The Board of Trustees of Reclamation District No. 1007 shall review this plan at least once every three years and after any major flood event where the plan was used to guide District response. The District Secretary shall maintain a record of Board plan reviews and approval actions in accordance with District documentation procedures and policies.

Sincerely,

John Vieira, President  
Board of Trustees  
Reclamation District 1007

# Record of Changes

Revision #	Sections Revised	Date of Distribution	Name of Approving Authority

# Record of Initial Distribution

<u>Agency Name</u>	<u>Address</u>	<u>Date Provided</u>
San Joaquin County Office of Emergency Services	2101 E. Earhart Ave. Suite 300 Stockton, CA 95206	
San Joaquin County Sheriff's Office	7000 Michael Canlis Blvd French Camp, CA 95231	
Department of Water Resources Flood Operations Branch	3310 El Camino Ave Sacramento, CA 95821	
California Office of Emergency Services	3650 Schriever Ave Mather, CA 95655	
Central Valley Flood Protection Board	3310 El Camino Ave. Rm 151 Sacramento, CA 95821	

# Table of Contents

Section		Page
1	Plan Introduction	1
	1.1 Purpose	1
	1.2 Scope	1
	1.3 Plan Structure	1
2	Concept of Operations	3
	2.1 Situation Overview	3
	2.2 General Approach to Seasonal Flood Operations	5
	2.2.1 Routine Preparedness and Infrastructure Maintenance	5
	2.2.2 Monitoring and Analysis Levee Procedures and Considerations	6
	2.2.3 Alerting, Activation, and Initial Response	7
	2.3 Public Notification	9
	2.4 Flood Fight Operations	9
	2.5 Federal and State Disaster Assistance	10
3	Organization and Assignment of Responsibilities	13
	3.1 Organization	13
	3.2 Assignment of Responsibilities	14
	3.2.1 Make Legal and Financial Commitments on behalf of District	14
	3.2.2 Represent District in Operational Area Emergency Management Committee	15
	3.2.3 Provide Public Information	15
	3.2.4 Maintain Emergency Supplies and Equipment	15
	3.2.5 Monitor Water Conditions, Elevations, and Forecasts	16
	3.2.6 Activate and/or Direct District Staff during Emergency Operations	16
	3.2.7 Document Expenditures, Emergency Actions, and Requests for Mutual Aid	16
4	Direction, Control and Coordination	17
	4.1 Management and Control of District Operations and Coordination within District	17
	4.1.1 Management and Policy	17

## Table of Contents, continued

4.1.2	District Incident Command	17
4.1.3	Incident Command Facilities	18
4.2	Management and Coordination with Other Jurisdictions	18
4.2.1	Unified Flood Fight Command Post	18
4.2.2	San Joaquin Operational Area Emergency Operations Center	18
4.2.3	State-Federal Flood Operations Center	19
4.2.4	San Joaquin Operational Area Joint Information Center	19
5	Communications	22
5.1	Communications Organization	22
5.2	District Communications	22
5.3	Communications with Other Jurisdictions	22
5.3.1	San Joaquin Operational Area EOC	23
5.3.2	Department of Water Resources State-Federal Flood Operations Center	23
5.4	Emergency Contact and Responders List	23
6	Logistics and Finance/Administration	24
6.1	Mutual Aid	24
6.2	Resources	25
6.3	Procurement	25
6.4	Logistics Facilities	27
6.5	Finance and Administration	27
7	Plan Development and Maintenance	28
7.1	Plan Development and Maintenance	28
7.2	Training and Exercises	28
7.3	Plan Evaluation	29
8	Authorities and References	30

# Attachments

- A. Annex A – Flood Contingency Map
- B. List of Acronyms and Glossary
- C. Description of Levee Sections
- D. Irrigation Pump Inventory & Levee Sections Map
- E. Emergency Response and Training Policy
- F. Delegation of Authority Letter
- G. Standard Contract Form
- H. Emergency Resolution Template
- I. Regulatory Notification Template
- J. PL 84-99 Request Template
- K. State of California Emergency Flood Fighting Methods, dated July 2012
- L. Office of Emergency Services After-Action-Report
- M. Engineer’s Levee Threat Assessment Document
- N. Levee Threat Monitoring Guidelines
- O. Levee Threat Mitigation Process
- P. San Joaquin County Office of Emergency Services Hazardous Materials Area Plan
- Q. Emergency Flood Fight Materials and Equipment Inventory List



# Section 1 - Plan Introduction

## 1.1 Purpose

The purpose of this Flood Safety Plan is to ensure that District personnel can meet District response objectives in an emergency as well as interact with other jurisdictions performing emergency functions within and around the District. This plan is intended to be used in conjunction with the State of California emergency operation plans and the San Joaquin County Operational Area (OA) to facilitate multi-jurisdictional coordination within District boundaries. Although this is a public document, specific procedures and information of a sensitive nature and personal information may be edited out of publicly available versions. The full document is subject to restricted-use handling procedures. This plan meets the requirements of section 9650 of the California Water Code.

## 1.2 Scope

Reclamation District No. 1007 (District), an independent jurisdiction, has responsibility for the maintenance of the levee on Pico Naglee Tract within its jurisdictional boundaries. The drainage system is operated and maintained by the Naglee Burk Irrigation District. While the District will work with, and assist if possible, the local jurisdiction(s) responsible for other public safety functions within the District, this Emergency Operations Plan (EOP) only contains detailed procedures for carrying out the emergency responsibilities of the District. The manner of interacting with other jurisdictions is described, but the operational plans of other jurisdictions with public safety responsibilities within the District are only referenced.

This plan will cover the following information:

- District Flood Preparedness Procedures
- District Levee Patrol Procedures
- District Flood Fight Procedures
- District Flood Water Removal Procedures
- District Recovery and After-Action Follow up Procedures

## 1.3 Plan Structure

This Flood Safety Plan is structured as a traditional functional emergency operations plan in accordance with Comprehensive Preparedness Guide (CPG) 101 issued by the Federal Emergency Management Agency (FEMA). Consistent with that guidance, and the District's limited responsibilities and lack of internal departments, this Emergency Operation Plan consists of this Basic Plan, with an overview of District response procedures, and one hazard-specific annex, Annex A – Flood Contingency Map (Annex A), Annex A contains details of the District's flood response plan. The District's most current Flood Contingency Map can be accessed

at the San Joaquin Operational Area flood contingency map website, [www.sjmap.org/oesfcm](http://www.sjmap.org/oesfcm) (see Figure 1).

**sjmap.org**  
San Joaquin County California, USA

**O.E.S. Flood Contingency Mapping**

[Flood Contingency Map Index \(PDF\) \(2.5M\)](#)  
[SJC OES FCM Naming Standards \(PDF\) \(81K\)](#)

**VISUAL INDEX OF AVAILABLE MAPS**

*(green areas are completed maps, click to view pdf)  
(red areas are scheduled for mapping, but are not yet completed)*

**TABULAR INDEX OF AVAILABLE MAPS**

Official Map Name	Map PDF	Preliminary Engineering Designs PDF
Bacon Island	<a href="#">Quad (2.9M)</a>	PED
Boggs Tract	N/A	N/A
Black Canal Tract	<a href="#">Quad (12.0M)</a>	N/A
Central Stockton	N/A	N/A
Delta Islands North	N/A	N/A
Eight Mile Corridor	<a href="#">Quad (8.2M)</a>	PED
Highway 12 Corridor	<a href="#">Quad (25.7M)</a>	PED
Jones Tract	N/A	N/A
McDonald Island	<a href="#">Quad/Aerial (30.1M)</a>	PED
New Hope Tract	<a href="#">Quad (16.1M)</a> <a href="#">Aerial 2004 (12.9M)</a>	N/A
North Stockton	N/A	N/A
Old River	N/A	N/A
RD1508 Lincoln Village West	<a href="#">Base (645K)</a>	PED
RD17 Mossdale	N/A	N/A
RD2074 Sargent Barnhart	<a href="#">Base (841K)</a>	PED
Rindge Tract	<a href="#">Quad (1.7M)</a>	PED
Roberts Island	<a href="#">Quad (5.1M)</a> <a href="#">Serial (24.1M)</a>	N/A
Rough And Ready Island	N/A	N/A
San Joaquin River East Bank	<a href="#">Quad (5.1M)</a> <a href="#">Serial (28.4M)</a>	N/A
San Joaquin River West Bank	<a href="#">Quad (7.5M)</a> <a href="#">Aerial 1998 (28.3M)</a> <a href="#">Aerial 2004 (61.1M)</a>	PED
Smith Weber Tract	N/A	N/A
South Stockton	<a href="#">Quad (7.2M)</a>	N/A
Staten Island	N/A	N/A
Stewart Mossdale Tract	N/A	N/A
Union Island	<a href="#">Quad (18.3M)</a>	PED
Victoria Canal	<a href="#">Quad (13.6M)</a> <a href="#">Serial 2004 (11.6M)</a>	N/A
Wright Elmwood Tract	N/A	N/A

**OTHER MAPS:**  
[Reclamation Districts \(PDF\) \(4.9M\)](#)  
[Unified Flood Fight Commands \(PDF\) \(5.0M\)](#)

**Figure 1:** San Joaquin Operation Area Website  
[www.sjmap.org/oesfcm](http://www.sjmap.org/oesfcm)

## Section 2 – Concept of Operations

### 2.1 Situation Overview

The District is responsible for maintaining the Pico Naglee Tract levees that protect agricultural, urban, and commercial land. The majority of the land is agricultural and residential housing; however, there are special improvements that have significant risks in the event of flooding which will be described later in this section.

Pico Naglee Tract Reclamation District No. 1007 is located in the San Joaquin Valley north of Interstate 205 and the City of Tracy. The District is located within the secondary zone of the legal Delta. It comprises nearly 6,100 acres of land and about 8.5 miles of non-project levee along the south bank of the Old River and a portion of the Sugar Cut. The levee stationing begins at Sugar Cut (Station 0+00) just south of Whitehall Road and proceeds counterclockwise to Tom Paine Slough (Station 48+00) and Old River (Station 106+00). The Stationing continues along Old River and ends at the mouth of WID Canal (Station 446+00). The District levees protect land that is between 15 and -5 feet below sea level. A detailed description of the District levees is attached (see Appendix C).

The District levees protect over 5,000 acres of agricultural production. This acreage has ranch and farm facilities as well as associated farming equipment. There are many grain and feed storage facilities which at any time could have large surplus of valuable commodities. Crops produced include row crops. Additionally, there are extensive cattle operations within the District. Large populations of cattle are constantly on the Tract along with accompanying water quality treatment facilities associated with raising cattle. There is a large waste feed facility (approximate 120 acre) which stockpiles and treats large volumes of rotting grain and silage. The following are the special improvements that have significant risks in the event of flooding:

#### Critical State Infrastructure:

##### *Interstate 205*

The District is located just north of Interstate 205. The ground rises to an elevation of +20 feet near Interstate 205. A breached levee could possibly adversely affect Interstate 205.

##### *High Power Electrical Lines*

High power electrical lines cross the District in a few locations. If these lines were to be damaged, it would affect the City of Tracy and nearby communities.

Public Facilities:

*Tracy Boulevard*

This San Joaquin County road connects Highway 4 to Interstate 205. There is a bridge located on Tracy Boulevard that crosses Old River. Tracy Boulevard would be the main evacuation route for Districts north of Pico Naglee to get to higher ground near interstate 205. During a flood situation, it is important to protect Tracy Boulevard.

*City of Tracy Sewage Treatment Plant*

The City of Tracy has tertiary sewage ponds (approximately 200 acres) located adjacent to Pico Naglee. This sewage treatment plant services many people, and inundation of Pico Naglee could have a significant impact on the treatment facility.

*Naglee Burk Irrigation District - Drainage System*

Naglee Burk Irrigation District is responsible for providing drainage within the Pico Naglee Tract. The land is below the level of the waterbody and requires pumps to discharge the drainage from the tract. There are associated ditches and canals that are used to convey the water to the pumps. The drainage system is very sensitive due to the relative flatness of the tract. Any increase in the water level can impact the surrounding land especially the lower sections. An extended interruption of electrical service will cause water to backup and rise in the district ditches.

The Naglee Burk Irrigation District maintains and operates 5 drainage pump station adjacent to the levees. Many of the pump tests have been recently performed and the results are as follows:

**Pump Station #13 (on Sugar Cut)**

Pump #	HP	Calculated Flow (gpm)	Measured Flow (acre-ft per 24 hrs)
1	15	2512	11.1
2	15	3568	15.8

**Pump Station #10 (Station 149+00)**

Pump #	HP	Measured Flow (gpm)	Measured Flow (acre-ft per 24 hrs)
1	15	4979	22.0
2	25	3736	16.5
3	60	8515	37.7

**Pump Station #14 (Station 262+00)**

Pump #	HP	Measured Flow (gpm)	Measured Flow (acre- ft per 24 hrs)
1	10	840	3.7

**Pump Station #9 (Station 280+00)**

Pump #	HP	Calculated Flow (gpm)	Calculated Flow (acre-ft per 24 hrs)
1	10	850	3.7

**Pump Station #3 (Station 330+00)**

Pump #	HP	Calculated Flow (gpm)	Calculated Flow (acre-ft per 24 hrs)
1	30	2970	4.7

See the San Joaquin Operational Area Hazard Mitigation Plan for a comprehensive flood risk assessment for the County of San Joaquin. See Annex A - for District boundaries, levees, pumping stations, supply depots, historical flooding summary, locations of past breaches and areas of historic seepage or erosion, topography, and characteristics of waterways fronting District levees.

Population

There are approximately 200 homes and ranches below the flood plain on Pico Naglee Tract. Additionally, there are industrial parks located on the southern end of the District. The West Valley Mall is in close proximity to District to the south. As mentioned above, there are numerous livestock operations within the District. At any given time, 1,000 to 5,000 people may need to be evacuated during a flood event.

**2.2. General Approach to Seasonal Flood Operations**

The District staff will carry out routine preparedness activities at the beginning of the flood season as described in this section. Annex A of this plan describes the concept of operations and protocols for active District flood fight activities. Section 3 of this Plan, Organization and Responsibilities, describes authorities and responsibilities for performing routine and emergency activities.

**2.2.1 Routine Preparedness and Infrastructure Maintenance**

The District has been tasked to prevent, reduce and mitigate the risk of damages associated with flooding. It is the District's goal to prevent loss of life and damage to property and infrastructure. The following is a list of routine District actions and

procedures for ensuring preparedness of personnel, equipment, and materials prior to the beginning of flood season:

- District staff performs routine inspections of drainage and levee facilities to identify any existing deficiencies. If any deficiencies are identified, the District repairs them as necessary.
- Emergency equipment and supplies are routinely inspected and inventoried.
- District staff reviews their Flood Emergency Plan prior to the flood season.
- District staff reviews the DWR Emergency Flood Fight Methods prior to the flood season.

### 2.2.2 Monitoring, Analysis, Levee Procedures, and Considerations

Throughout flood season, District personnel will visually monitor and analyze the water conditions, elevations, and forecasts for waterways affecting District works for the purpose of promptly identifying heightened threats to the integrity of levee and drainage systems. The objective of this monitoring effort is to identify conditions that warrant additional actions beyond routine flood season preparedness activities. Monitoring and analysis will be in accordance with DWR Levee Threat Monitoring Guidelines (see Attachment N).

Flooding on Pico Naglee Tract can be caused by levee issues or failure of the District pumping facilities. Flooding events can be characterized into Levee Flood and Drainage Flood Situations, Flood Threats, and Levee Leak / Breach.

#### Levee Flood and Drainage Flood Situations

Levee Flood Situations are caused by a number of factors, such as high water events (tides/reservoir releases), storms and wind, leaks (seepage, burrowing animals and penetrations) upstream flood control capacity, and snow pack.

Drainage Flood Situations are minor interruption of electrical service to pumping plants, damages to pumping facilities, and clogging of drainage ditches/culverts. Also, in the event of a power outage within the area, temporary generators would have to be delivered to power the pumps stations.

These two situations are concerns, but not a threat. The situations are monitored or remedied in a timely manner.

#### Flood Threats

Flood Threats generally occur with combinations of the above situations and will initiate additional monitoring and flood patrols. An example would be a high-water

event with high storm generated winds. During flood threats, monitoring is performed during the high tide with follow up at low tide if damage is suspected.

### Levee Leak / Breach

If a leak or a breach in the levee is discovered, it will be monitored continuously and repaired immediately. The District will notify additional resources for assistance if the situation has potential to threaten life and safety.

Levee patrols are a precautionary measure to monitor levee conditions and identify potential areas of weakness or failure. Patrols are typically increased upon issuance of river stage warnings from DWR. The District's flood stage monitoring is comprised of observing the readings from specific real time, telemetered stream gages that report the conditions on water courses that affect potential flooding in the jurisdiction, including high river stages, high tides and cycle times, and reservoir releases.

The District will monitor the California Data Exchange Center (CDEC) gages by using the following station gages and information source in its overall monitoring effort; M=Monitor Stage, F= Flood Stage, and D=Danger Stage. The following Stations are on the NAVD88 Datum.

- Mokelumne River at Bensons Ferry near Thornton (BEN) (M=12.0, F=17.0)
- Sacramento River at Rio Vista Bridge (RVB) (M=7.4, F=11.9, D=12.9)
- San Joaquin River at Mossdale Bridge (MSD) (M=19.5, F=28.5, D=29.5)
- Delta Pool: Bacon Island at Old River (BAC) (M=6, F=8, D=9)

### 2.2.3 Alerting, Activation, and Initial Response

River conditions and CDEC station gage information will be monitored to detect the following conditions which will trigger the Response Stage Actions shown below. These, and additional actions as directed by Trustees, may be taken by District staff at any time it is felt that conditions affecting levee protection and drainage system warrant such action.

**Level 1 Normal Stage – Non-Emergency status** (River Stage = Average high tide elevations below Level 2 Monitor Stage) (*Normal winter weekly patrol*)

- Superintendent patrols the levee on a normal basis with additional monitoring of areas of concerns

**Level 2 Monitor Stage – Increased Observation** (River Stage = Seasonal high tides. At this stage, water levels are approaching 5 feet below the top of levees and 2 feet below the Level 3 Flood Stage) (*Increased observation of levees*)

- Superintendent patrols the levee on a normal basis with additional monitoring of areas of concerns.
- Activate District staff as necessary for patrol assistance or repairs if needed.
- Establish contact with the County Office of Emergency Services that the District is monitoring the levee at high monitor stage.

**Level 3 Flood Stage** (River Stage = Higher than seasonal tides with additional contributing situations such as wind, storm, or large releases from reservoirs. At this stage, there is a minimum 3 feet of freeboard to the top of the levees) (*Levees monitored daily during high tides*)

- Superintendent patrols the levee during daytime high tide with additional monitoring of areas of concerns.
- Activate District staff as necessary for patrol assistance or repairs if needed.
- Establish contact with the Local and State-Federal Flood Operations Center that the District is monitoring the levee at high monitor stage.
- Upon the identification or verified report of any out of the ordinary condition on a District levee that presents a potential risk of failure District staff will initiate repairs or delivery of potential repair materials.

**Level 4 Danger Stage** (River Stage = Higher than flood stage with additional contributing situations such as wind, storm, or large releases from reservoirs. At this stage, the waters levels are 1 foot above Level 3 Flood Stage) (*Levees monitored continuously during high tides*)

- Superintendent patrols the levee during daytime high tide with additional monitoring of areas of concerns.
- Activate District staff as necessary for patrol assistance or repairs if needed.
- Maintain contact with the Local and State-Federal Flood Operations Center that the District is at danger stage.
- Upon the identification, or verified report, of any out of the ordinary condition on a District levee that presents a potential risk of failure, District staff will initiate repairs or delivery of potential repair materials.
- After compiling, monitoring and surveillance information, the District decides if it is necessary to begin flood operations or direct flood fight resources to specific areas where flooding may occur soon. The District's emergency personnel also monitor the flood stage information or monitoring system and are in constant communication with flood control staff throughout the storm episode.
- The severity of the situation will determine if evacuations are necessary based on infrastructure at risk and people immediately affected in the



inundation zone. See Section 2.3 for further information about evacuations.

### **2.3 Public Notification**

In the event the District has prior notice or otherwise believes a levee failure appears imminent or has occurred, District personnel will immediately notify the following agencies:

- San Joaquin County Sheriff's Office
- San Joaquin Operational Area Emergency Operations Center (EOC)

The San Joaquin County Sheriff's Office is responsible for alerting, warning and evacuating the general public through the San Joaquin Operational Area using the procedures contained in the SJOA Warning Annex (see [www.sjgov.org/oes](http://www.sjgov.org/oes)). Procedures should accommodate the provisions of the Americans with Disabilities Act within District boundaries. The District will promptly notify this jurisdiction of identified threats to its levees or internal drainage system and provide detailed information on the characteristics of the threat. The District will assist, to the extent possible, with notification of the public if requested. The District will provide a representative to the Operational Area and SJOA Joint Information Center to assist with alert and warning messages if requested.

The local Office of Emergency Services (OES) may receive direct warning from DWR, NWS, or the California Office of Emergency Services (CalOES). The U.S. Bureau of Reclamation (USBR), USACE, or other agency that locally controls dams will advise of dam incidents, significant releases, or significant changes in releases. The San Joaquin County Sheriff's Office is responsible for warnings and evacuations activities in unincorporated areas, which includes but not limited to general warnings, population warnings, traffic direction and control, evacuation and care for pets and livestock, emergency medical care, transportation management, shelter and feeding operations, and emergency food and water distributions.

### **2.4 Flood Fight Operations**

Flood fight operations will be conducted in accordance with the procedures in this Plan and those shown on Annex A. Annex A displays the District's concept of operations for emergency communications, patrol, flood fight, and dewatering operations. This concept of operations will be modified as needed to meet the demands of actual emergency conditions. Plans of jurisdictions with responsibility for warning and evacuation within the District are referenced on the Annex A as well as in this plan.

Situations that require flood fight procedures include:

- Waterside sloughing or erosion of slope protection.
- Waterside beaver den collapses.
- Increased seepage.
- Levee Crown Cracking or slumping.
- Naglee Burk Irrigation District pumping plan malfunctions.

Repairs will be made during low tides. Generally, levee materials will be brought to the site in trucks specified by the Engineer. In the event access is restricted, marine equipment will be utilized. If marine equipment is not readily available, onsite borrow material could be developed and utilized. Contractors or District personnel will be used to provide equipment. Pump Station malfunctions will be performed with pump specialists or coordinated with PGE for electrical repairs.

In the event levee materials or equipment cannot be used, CCC crews or other labor forces will be utilized to implement flood fight procedures listed in the DWR flood fighting procedures manual.

The District Engineer has prepared and estimated an inundation flood time spreadsheet for the time it takes for flood waters to fill the island to a range of different elevations, based on the levee breach lengths and the river's water level. These values will be implemented to approximate the amount of time it will take for the District to flood and to estimate the time and the required additional pumps it will take to dewater the District.

All Irrigation Pumps shall be shutoff. The locations of the existing irrigation pumps are shown on the Irrigation Pump Inventory and Levee Sections Map (see Attachment D).

In the event of a State or County declared emergency, the District will complete the Office of Emergency Services After-Action-Report (AAR) and reference the Engineer's Levee Threat Assessment Document and the Levee Threat Mitigation Process (see Attachments L, M, and O).

Hazards materials shall be handled in accordance with the San Joaquin County Office of Emergency Services Hazardous Materials Area Plan (see Attachment P).

## **2.5 Federal and State Disaster Assistance**

The District's policy is to maintain mitigation and emergency plans and procedures, as well as the physical condition of its levees, at the level required to be eligible for disaster public and individual assistance programs such as the Federal Stafford Act and the California Disaster Assistance Act (CDAA).

Emergency operations will be conducted and documented in compliance with conditions of those programs for reimbursement of disaster expenses. The District has assigned its District Engineer to maintain necessary documentation during an emergency and to participate in any available assistance programs after a disaster on behalf of the District.

In the event that a flood fight situation is beyond the financial capabilities of the District, additional resources will be sought from Local, State and Federal agencies.

- The DWR Delta Levee program will be contacted and notified of the situation. The first step is a request for emergency funding of \$50,000 from the reserve funds of the special/subventions projects program.
- If the cost is projected to be more than \$50,000, a budget will be developed and requested of the special projects program or a revision to the District's subvention application amount.
- In the event a State emergency proclamation is made, the District will work with the San Joaquin County Office of Emergency Services (OES), coordinating with CalOES for financial assistance. The assistance will be made through the California Disaster assistance Act (CDAA) (Title 19, Division 2, Chapter 6, Article 1, 2950)
- In the event a Federal emergency declaration is made, FEMA will be contacted for financial assistance. The assistance will be made through PL 93-288 (The Stafford Act) and again coordinated with The County and /or CalOES.

In addition, the District's policy is to maintain emergency plans and procedures, for disaster public PL84-99 program.

To ensure that the District takes steps to quickly access the recovery process, these actions should be considered if an incident is imminent or occurring:

- PL-84-99:
  - Pre-develop a USACE PL84-99 request letter on District letterhead, see Attachment K
  - Contact DWR Flood Operations Center
  - Follow-up call to USACE District office that a request was made to DWR
  - Notify Operational Area of PL84-99 request, send copy of written request
- State and other Federal programs:
  - Request San Joaquin County to Proclaim the Existence of a Local Emergency

Emergency operations will be conducted and documented in compliance with conditions of those programs for reimbursement of disaster expenses. The District has assigned its District Engineer to maintain necessary documentation during an

emergency and to participate in any available assistance programs after a disaster on behalf of the District.

# Section 3 – Organization and Assignment of Responsibilities

## 3.1 Organization

The District will use its paid, contract, and volunteer staff as shown below to perform its responsibilities in a flood emergency.

The District is currently organized as follows (see Figure 2):

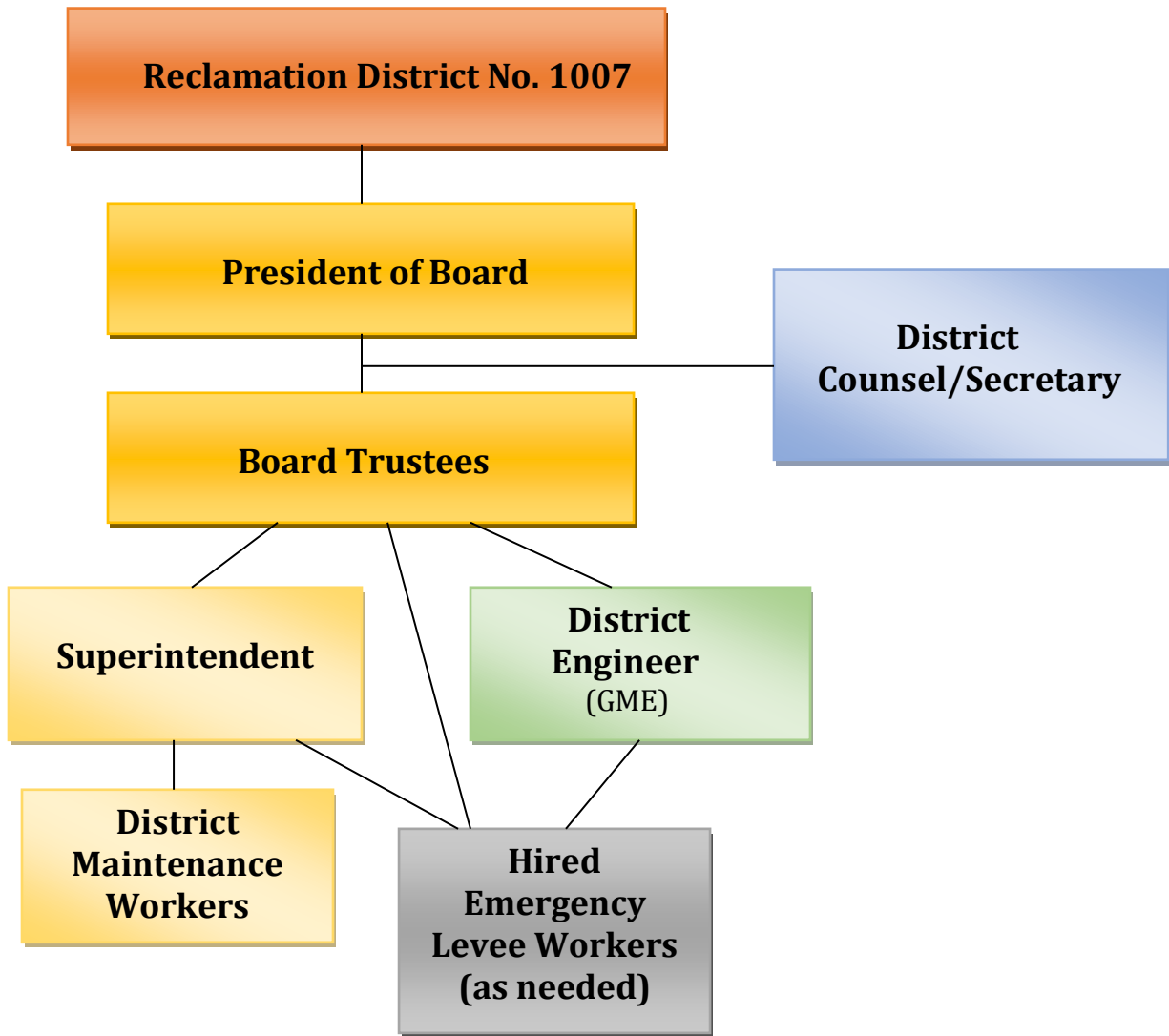

Figure 2: District Organizational Chart

## 3.2 Assignment of Responsibilities

The District Board of Trustees has made the following assignments of authority and responsibility to ensure that needed emergency actions can be taken promptly and efficiently.

### 3.2.1 Make Legal and Financial Commitments on behalf of District

The Board, through a resolution approved by a majority, is authorized to:

- Authorize expenditures.
- Authorize the engineer/secretary to solicit bids and award contracts.
- Hire additional consultants as may be required.

Individual Trustees are authorized to:

- Purchase supplies and equipment up to \$5,000 for District use.
- Request the Operational Area Logistics Section to acquire resources on behalf of the District.
- Maintain District equipment, supplies, and resources.
- Activate District staff and resources.
- Activate/Direct and/or supervise District personnel, contractors, and other staff provided to District under mutual aid.
- Requesting from, or providing assistance to, other jurisdictions under mutual aid provisions.

The District Superintendent/Secretary and Engineers are authorized to:

- Purchase supplies and equipment up to \$5,000 for District use.
- Request operational Area logistics to acquire resources on behalf of the District.
- Maintain District equipment, supplies and resources.
- Activate/Direct and/or supervise District personnel, contractors, and other staff provided to District under mutual aid.
- Requesting from, or providing assistance to, other jurisdictions under mutual aid provisions.
- Spend up to \$25,000 for an emergency situation with verbal approval of at least two board members.
- Organizing and directing financial and recovery activities.
- Document District expenditures and emergency actions.
- Document and submit disaster assistance claims during the recovery period.
- Prepare and apply for local, State & Federal disaster assistance.

The District Trustees, District Superintendent, District Engineer, and District Secretary shall sign written contracts with private vendors or other public agencies stemming from emergency actions as mentioned above.

### 3.2.2 Represent District in Operational Area Emergency Management Committee

The Board President will issue a Delegation of Authority letter (see Attachment G) confirming and defining these specific authorities at the time of an emergency and formally identifying the District Incident Commander and Deputy Incident Commander upon reaching the trigger condition described in Section 2.2.3.

The District President, District Secretary, and the Incident Commander are authorized to:

- Represent the District at unified field commands as may be established by the San Joaquin Operational Area
- Represent the District at the San Joaquin Operational Area
- Delegate personnel to represent the District in Multi Agency Coordination (MAC) meetings, reporting of levee conditions, recommendations for public safety and consideration of modifying district response

### 3.2.3 Provide Public Information

District President is authorized to:

- Speak to the media on behalf of the District
- Assign the Secretary as the District Public Information Officer

Individual District Trustees are authorized to:

- Represent the District as an agency representative

The District Superintendent/Secretary and Engineers are authorized to:

- Represent the District as an agency representative in coordinating with Local, State, and Federal agencies.
- Address public information and rumor control

### 3.2.4 Maintain Emergency Supplies and Equipment

The District Superintendent or District Engineer are authorized and responsible for maintaining the District's emergency flood fighting supplies. Additionally, the following District personnel are authorized for the following actions:

The Board, through a resolution approved by a majority, is authorized to:

- Approve expenditures for emergency supplies and equipment.

Individual Trustees are authorized to:

- Purchase supplies and equipment up to \$5,000 for District use.
- Request the Operational Area Logistics Section to acquire resources for the District.
- Maintain District equipment, supplies and resources.

The District Superintendent/Secretary and Engineers are authorized to:

- Purchase supplies and equipment up to \$5,000 for District use.
- Delegate repairs.
- Maintain District equipment, supplies and resources.
- Requesting from, or providing assistance to, other jurisdictions under mutual aid provisions.

### 3.2.5 Monitor Water Conditions, Elevations, and Forecasts

The District Superintendent and District Engineer are responsible for:

- Monitoring water conditions, elevations, and forecasts

### 3.2.6 Activate and/or Direct District Staff during Emergency Operations

The District Incident Commander, as assigned by the District President, is authorized to:

- Activate District staff and resources
- Request or provide mutual aid assistance from public agencies
- Supervise District staff, contractors, and/or mutual aid resources assigned to District for levee patrol, flood fight operations, and District de-watering operations.

The Board will use the Emergency Resolution Template (see Attachment H) to proclaim a local emergency. The Board President will issue a Delegation of Authority letter (see Attachment F) assigning a District Incident Commander as noted in Section 3.2.2.

### 3.2.7 Document Expenditures, Emergency Actions, and Requests for Mutual Aid

The District Engineer and District Secretary or elected official are authorized to:

- Maintain necessary documentation of emergency expenditures
- Document District expenditures and emergency actions.
- Document and submit disaster assistance claims during the recovery period.
- Prepare and apply for disaster assistance claims during the recovery period through all local, federal, and state disaster assistance programs



## Section 4 – Direction, Control, and Coordination

### **4.1 Management and Control of District Operations and Coordination within District**

District staff are authorized and responsible for carrying out the actions outlined in Section 3, Organization and Responsibilities. The District will use the direction, control, and coordination facilities and management processes described in this section. Communications and logistics systems for command, coordination, and response are described in Sections 5 and 6.

The District Engineer maintains an up-to-date call list.

In the event that the situation is beyond the District's and DWR's financial capabilities or a state or federal disaster is proclaimed or declared, the District will coordinate with the San Joaquin County Office of Emergency Services (OES). OES and the District will apply the National Incident Management System (NIMS) and the Standardized Emergency Management System (SEMS) to organize response activities. District personnel and OES staff will comply with the procedures of the San Joaquin County Unified Flood Fight Command, to which the District is assigned, the San Joaquin Operational Area Multi-Agency Coordination System (MACS), or any other "as needed" command structure put in place by local officials purposes of inter-agency coordination.

#### 4.1.1. Management and Policy

District staff authorized and responsible for carrying out the actions outlined in Section 3, Organization and Responsibilities, will use the direction, control, and coordination facilities and processes described in this section. Communications and logistics systems for command, coordination, and response are described in Section 5 and 6.

The Board President will issue a Delegation of Authority letter (see Attachment F) appointing a District Incident Commander upon reaching the trigger condition indicated in Section 2.2.3. The District Incident Commander will be responsible for all District emergency actions.

#### 4.1.2 District Incident Command

The District will appoint one incident commander to manage all individual incidents occurring on the District levee system as an "incident complex" during any single disaster event as allowed in NIMS protocols. The District Incident Commander at the flood fight scene is in charge of all resource responding to that emergency site. The District Incident Commander may assign missions to flood fight crews acquired under mutual aid from other governmental agencies, tasking them to perform

specific tasks to facilitate the response. The District will operate on a 24-hour operational period.

#### 4.1.3 Incident Command Facilities

The Incident Command Center of Operation is the meeting location to make decisions during an emergency. It is located at the open field located near the intersection of Pavilion Parkway and Naglee Road, adjacent to State Highway 205 (preliminary Supply and Delivery Point).

## 4.2 Management and Coordination with Other Jurisdictions

The District will ensure that proper management and coordination is maintained with 1) other public agencies and jurisdictions operating within the District, 2) neighboring reclamation districts, and 3) the San Joaquin Operational Area. The following procedures will be followed to accomplish this function. Communications will be established, and MAC meeting will be attended by authorized representatives.

### 4.2.1 Unified Flood Fight Command Post

The County of San Joaquin has established four pre-planned unified flood fight commands with pre-identified command post locations to facilitate coordination and mutual aid between neighboring reclamation districts and supporting city/county, state, and federal agencies. The District will provide a representative to its assigned unified flood fight command to coordinate the development and implementation of incident action plans. Unified situation assessment, resources, and tactical planning of multi-agency flood fight activities will take place within this unified command. See Unified Flood Fight Command Map at [www.sjmap.org/oesfcm](http://www.sjmap.org/oesfcm).

Reclamation District No. 1007 is a member of the South Delta Flood Fight Command Post established by the San Joaquin Operational Area. The South Delta Flood Fight Command meets at the Cardoza Hay Burn, located 100 meters west of Perrin Road and Airport Way intersection. The boundaries and assignments to this command may be viewed on the SJ County Unified Flood Fight Command Map available at [www.sjmap.org/oesfcm](http://www.sjmap.org/oesfcm) (see Figure 3).

### 4.2.2 San Joaquin Operational Area Emergency Operations Center

The County of San Joaquin maintains and hosts the San Joaquin Operational Area Emergency Operations Center (EOC) at 2101 E. Earhart Avenue, Stockton, in the Robert J. Cabral Agricultural Center. There could be other emergency facilities established under the OA-EOC located in separate locations.

The Operational Area Multi-Agency Coordination Group (MAC Group) may be activated to assist the EOC Director prioritize incidents for allocation of scarce resources including mutual aid, assists Planning/Intelligence in information sharing, and conduct resource coordination processes in accordance with the procedures maintained by San Joaquin County Office of Emergency Services. This group works closely with the OA-EOC Logistics Section.

The San Joaquin Operational Area Planning/Intelligence Section will provide disaster intelligence and situational status to participating jurisdictions upon activation in an emergency. This District will participate in this disaster intelligence and information sharing process. See [www.sjgov.org/oes](http://www.sjgov.org/oes) for relevant San Joaquin Operational Area plans and procedures.

The District Board of Trustees and Engineer plan to attend the annual pre-season flood coordination meeting. The District's ability to remote conference or communicate with the operational area is with cellular phones. The District is part of the South Delta Flood Fight Command and will use emergency meetings of that command organization to communicate with the County, operational area, and State agencies.

District is a signatory to the San Joaquin Operational Area Agreement, and as such, its Incident Commander will participate in SJOA multi-agency coordination processes and procedures on behalf of the District. General travel time from the District to the SJOA EOC is 30 minutes. The District Incident Commander may remotely communicate with the SJOA EOC through cellular telephone.

#### 4.2.3 State-Federal Flood Operations Center

The DWR has special authority under Water Code Section 128 to assist reclamation districts with flood fight operations. The DWR maintains the State-Federal Flood Operations Center (FOC) to perform these functions and support the operations of other State and Federal agencies. The District will maintain communications with the FOC in order to receive and provide information with that facility and to request technical assistance.

The District will attend planned information meetings and make necessary contacts. The District also has an emergency call list supplied from Department of Water Resources in the event of an emergency/flood.

#### 4.2.4 San Joaquin Operational Area Joint Information Center

Information to the general public and jurisdictions will also be coordinated, planned, and carried out through the San Joaquin Operational Area Joint Information Center (JIC). The District will assist with risk communication as

requested through the OA. See [www.sjgov.org/oes](http://www.sjgov.org/oes) for relevant San Joaquin Operational Area plans and procedures.

The District will provide an information officer as requested who will have authority to approve information releases. The District information officer will identify the location and schedule of the JIC from the San Joaquin Operational Area Public Information Officer at the beginning of the flood event.

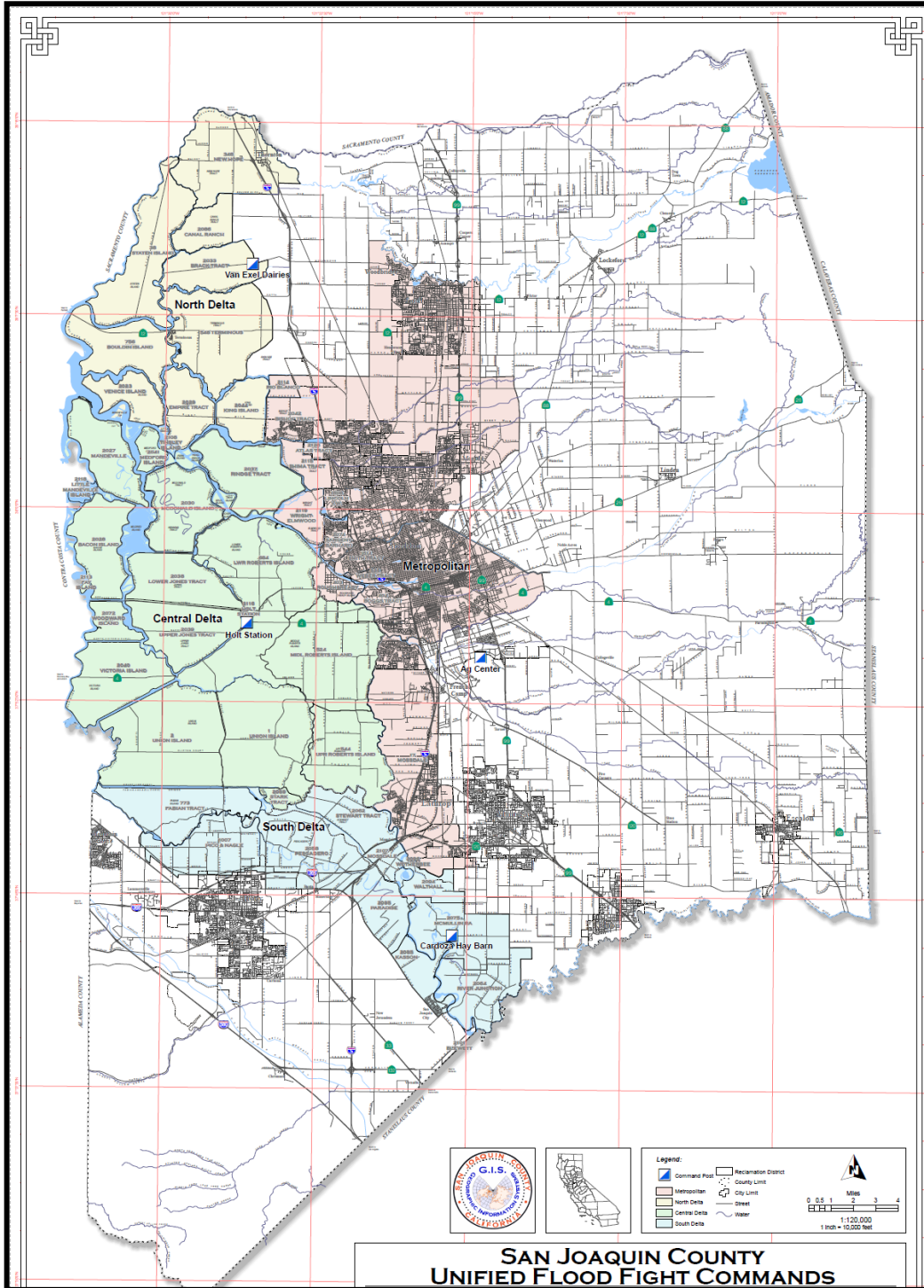

Figure 3: San Joaquin County Unified Fight Commands

## Section 5 - Communications

### 5.1 Communications Organization

The District will maintain adequate communications equipment to implement this emergency plan. This section identifies equipment and/or systems for communications:

- Between District staff, contractors, and other staff working under District supervision
- With other public agencies operating within the District
- With neighboring reclamation districts
- With the San Joaquin Operational Area EOC
- With the State Flood Operations Center

### 5.2 District Communications

The District does not own or operate communications equipment currently. The District will rely primarily on personal cell phones of its staff and trustees to maintain communications between the Board of Trustees, District Secretary, District Engineer, District Incident Commander, District levee patrollers, contractors, and volunteers conducting flood fight activities.

In the event an emergency flood event is anticipated or is imminent, levee patrols will be organized immediately by the District, and each patrol unit will have cellular phones for communications. The patrols will coordinate with the superintendent who will communicate with the Engineer. The engineer will communicate with the MAC with group emails as to flood situation developments.

The District office has use of office phone (land line) and cellular phone. Additionally the Trustees and Engineer can be contacted by email. Communication with cellular phones is the Districts best form of communications needs will be met.

There is an emergency call list for the District personnel as well as a list provided by DWR for the Districts supporting agencies. An emergency meeting will be called in the event of an emergency, and notification will begin with the call lists.

### 5.3 Communications with Other Jurisdictions

The District will maintain communications with other jurisdictions with cellular phones, office land line phone and email. Additionally, the District will participate in meetings of the South Delta Unified Flood Fight Command. Communication with cellular phones is the Districts best form of communication.

### 5.3.1 San Joaquin Operational Area Emergency Operation Center (EOC)

The District will maintain communications with the San Joaquin Operational Area EOC by cellular telephone and participate in scheduled meetings of the SJOA management. The District will maintain telephone numbers assigned by the SJOA for use by reclamation districts to contact the EOC.

### 5.3.2 Department of Water Resources State-Federal Flood Operations Center

The District will communicate with the Flood Operations Center and the San Joaquin Operational Area by cellular phone. Additional communications equipment may also be provided to ensure contact.

The District has a flood emergency call list provided by DWR for all area support.

## **5.4 Emergency Contacts and Responders Call List**

The District Engineer maintains an up-to-date Emergency Contacts and Responders call list for the District personnel, Local and State Agencies, Contractors, Material Suppliers, Material Deliverers, and Rental Yards.

## Section 6 – Logistics and Finance/Administration

### 6.1 Mutual Aid

The District is a signatory to the California Master Mutual Aid Agreement and the San Joaquin Operational Area Agreement, and will follow the processes outlined in those documents for requesting and providing mutual aid. The San Joaquin Operational Area Agreement and San Joaquin County Ordinances have provisions allowing the San Joaquin Operational Area Logistics Section and San Joaquin County Purchasing Agent to acquire and transport, on behalf of the District, resources requested by the District.

Mutual aid requests for technical assistance and services, flood fight crews, supplies and materials, and other resources will be made through the San Joaquin Operational Area Logistics Section and/or the Operational Area Public Works Mutual Aid Coordinator. See [www.sigov.org/oes](http://www.sigov.org/oes) for OA plans and procedures.

This Emergency Operations Plan is a component of that plan designed to apply local resources in meeting flood response requirements of the immediate community or its neighbors. This Emergency Operations Plan is coordinated with those of neighboring jurisdictions to ensure mutual compatibility.

The District records and reports on all District flood response personnel time. The District collects and maintains documentation on all emergency information needed for reimbursement by CalOES, FEMA, or other state or federal agencies. The District will meet the requirements to retain these records for audit purposes for three years after receiving the last FEMA payment for flood-related expenditures.

Comprehensive resource management is a key management principle. It implies that all assets and personnel during an event need to be tracked and accounted for. It ensures maintenance of accountability over all resources. Thus, they can be moved quickly to support preparation and response to an incident and ensure a fluid demobilization.

Resource management involves coordinating and overseeing the acquisition and deployment of tools, supplies, equipment, and people during a flood. Resource management enhances the benefit of mutual-aid agreements and improves interoperability. The objective of resource management is to:

- Maximize efficient resource use while maintaining cost-effectiveness and resource safety
- Consolidate control of single resources in order to reduce communications activity
- Instill resource accountability



Flood response resources include personnel or equipment to perform a specific operation and supplies and facilities to support on-scene incident operations. The SEMS Logistics Section typically orders supply items (e.g. food) and facilities (e.g. equipment staging). The SEMS Finance/Administration Section tracks the use of and maintains records on the resources applied to flood response.

## **6.2 Resources**

The District maintains a stockpile of material located at Sugar Cut (near levee Station 0+00) and at the WID Canal (near state 440+00). The District's ideal stockpile list can be found in Attachment Q. The District is in the process of completing what is actually kept on-site. In the event of an emergency or flood, the District shall contact San Joaquin County Office of Emergency Services and/or a material supplier contractor to have additional flood fight materials delivered to the pre-designated location as described in section 6.4. The location is shown in Annex A. San Joaquin Operational Area maintains seven twenty-foot containers with flood fight supplies that the district can draw on through the San Joaquin Operational Area Agreement. Inventory of that resource can be obtained from San Joaquin Operational Area. In addition, the DWR stores resources near the Port of Stockton.

The San Joaquin County has established a pre-planned unified flood fight command with pre-identified command post location to facilitate coordination and mutual aid between neighboring reclamation districts and supporting city/county, state, and federal agencies. The District is included in the South Delta Flood Fight Command at the Cardoza Hay Burn, located 100 meters west of Perrin Road and Airport Way intersection. See Unified Flood Fight Command Map at [www.sjmap.org/oesfcm](http://www.sjmap.org/oesfcm). The District's pre-designated location as described in section 6.4.

## **6.3 Procurement**

The District maintains standard forms and processes for initiating and executing contracts with private vendors. The District maintains a standard contract form for contracts under \$25,000 in a no-bid environment. The District maintains a separate contract form for contracts over \$25,000 adding a bonding requirement. Contracts over \$25,000 will be awarded through an informal bid process if practicable in light of emergency conditions. If an emergency situation is present, the District may administer contracts as legally allowed under a declared emergency.

The Board of Trustees, Superintendent, and/or District Engineer would work together for procuring supplies needed from DWR and purchasing in an emergency as needed. The Board would forego bids in the event of emergency.

The Board of Trustees will appoint and assist the Superintendent and/or District Engineer for procuring supplies and materials during an emergency.

When local personnel resources are depleted or reasonably committed, mutual aid is requested and coordinated within the OA. If OA resources are not sufficient or timely, the request is then forwarded by the OA to the CalOES Regional Emergency Operations Center (REOC). The REOC evaluates and fills requests by:

- Staff from unaffected OAs
- Tasking a State agency
- Accessing federal assistance

The foundation of California's emergency planning and response is a statewide mutual aid system. Mutual Aid is designed to ensure that adequate resources, facilities, and other support are provided to jurisdictions whenever their own resources prove inadequate to cope with a situation. The basis for the system is the California Disaster and Civil Defense master Mutual Aid Agreement, as provided for in the California Emergency Services Act. It created a formal structure, within which each jurisdiction retains control of its own personnel and facilities, but can give and receive help whenever it is needed. State government, on the other hand, is obligated to provide available resources to assist local jurisdictions in emergencies. The District has developed and maintains a current emergency plan compatible with the California Master Mutual Aid Agreement. This Plan is a component of that plan and is designed to apply local resources in meeting flood response requirements of the immediate community or its neighbors. This Plan is coordinated with those of neighboring jurisdictions to ensure mutual compatibility.

### Resource Tracking

Comprehensive resource management is a key management principle. It implies that all assets and personnel during an event need to be tracked and accounted for. It ensures maintenance of accountability over all resources. Thus, they can be moved quickly to support preparation and response to an incident and ensure a fluid demobilization.

Resource management enhances the benefit of mutual-aid agreements and improves interoperability. Resource management involves coordinating and overseeing the acquisition and deployment of tools, supplies, equipment, and people during a flood. The objective of resource management is to:

- Maximize efficient resource use while maintaining cost-effectiveness and resource safety
- Consolidate control of single resources in order to reduce communications activity
- Instill resource accountability

Flood response resources include:

- Personnel or equipment to perform a specific operation.
- Contractors and suppliers of flood fight materials and equipment.
- Supplies and facilities to support on-scene incident operations.

The SEMS Logistics Section typically orders supply items (e.g. food) and facilities (e.g. equipment staging). The SEMS Finance/Administration Section tracks the use of and maintains records on the resources applied to flood response.

#### **6.4 Logistics Facilities**

The pre-planned delivery point will be located at the open field located near the intersection of Pavilion Parkway and Naglee Road, adjacent to State Highway 205. See Annex A - for locations of pre-planned delivery point, locations of District supplies, and District supply staging areas and points.

#### **6.5 Finance and Administration**

The District maintains financial and administrative records associated with emergency response in accordance with *44 C.F.R. Part 13--Uniform Administrative Requirements for Grants and Cooperative Agreements to State and Local Governments*. Emergency response and construction records, including field reports, procurement, and construction management files, are maintained by both the District and the District Engineer and retained as prescribed by the grant authority. The District maintains a safety plan for employees and work rules as appropriate.

## Section 7 – Plan Development and Maintenance

### 7.1 Plan Development and Maintenance

The District Board of Trustees and District Engineer are responsible for overseeing the development of the Reclamation District No. 1007 Emergency Operations Plan. The District Engineer will maintain the District Flood Contingency Map which constitutes Annex A. The District Board President and District Engineer are responsible for periodic review of these documents to determine the need for revisions or updates.

The District Board will approve this plan when initially completed. The District President is authorized to approve routine updates and revisions. The District Board will review and re-approve the Emergency Operations Plan and Annex A at least every three years. Revised plans must be reviewed and approved by protected cities and the County.

### 7.2 Training and Exercises

The District will maintain a training program for its staff to ensure implementation of this emergency operations plan and to meet minimum federal and state requirements for disaster reimbursement. All District training will comply with the National Incident Management System (NIMS) and the Standardized Emergency Management System (SEMS). The District Emergency Response and Training Policy describes the Districts training program in detail (see Attachment E).

All District trustees, employees, and volunteers who have supervisory or management emergency assignments will receive at a minimum the following NIMS training and bi-annual refreshers as provided by the county:

- SEMS Introduction Course
- IS700 - NIMS An Introduction
- IS701 - NIMS Multi-Agency Coordination System
- IS800 - National Response Framework An Introduction
- ICS100- Introduction to the Incident Command System
- ICS200- ICS for Single Resources and Initial Action Incidents

In addition, District trustees and employees will receive training on the District EOP and Annex A. District personnel will participate in internal exercises and exercises sponsored by the San Joaquin Operational Area jurisdictions. When the District receives notification of upcoming training and exercises, the District will arrange to send proper personnel to that meeting as well as online training.

### **7.3 Plan Evaluation**

The District Engineer will prepare a written After-Action-Report (AAR) after any District-declared emergency affecting District levees. The Board will review and approve the AA, which will briefly describe District operations, any response problems that arose, and damage sustained by the District. The AAR will also contain recommendations for improving District emergency operations in the future. The Board will provide direction to staff as to the preparation of changes, additions, or revisions to the District emergency operations plan.

## Section 8 – Authorities and References

### **Federal**

Federal Civil Defense Act of 1950 (Public Law 920, as amended)

Robert T Stafford Disaster Relief and Emergency Assistance Act of 1988 (Public Law 93-288, as amended)

### **State**

California Emergency Services Act (Chapter 7, Division 1 of Title 2 of the Government Code)

Standardized Emergency Management System Regulations (Chapter 1 of Division 2 of Title 19 of the California Code of Regulations)

State of California Emergency Flood Fighting Methods, July 2012

State of California Office of Emergency Services After-Action-Report (AAR)

State of California Engineer’s Levee Threat Assessment, February 2012

State of California Levee Threat Monitoring Guidelines

State of California Levee Threat Mitigation Process

### **Local**

Ordinance Code of San Joaquin County 1995, Title 4 – Public Safety, Division 3. – Civil Defense and Disaster, Section 4-3008

Multi-Agency Coordination (MACS):

- San Joaquin Operational Area, MACS Procedures
- San Joaquin Operational Area, Evacuation Field Guide
- San Joaquin Operational Area, Multi-Hazard Functional Plan:
  - Section 6\_Hazard checklists (Flood Hazard Checklist)
  - Section 9\_MACS\_OA
- San Joaquin Local Hazard Mitigation Plan (LHMP)
- San Joaquin County Office of Emergency Services Hazardous Materials Area Plan

**Appendix A**  
**Annex A – Flood Contingency Map**

*See attached Flood Contingency Map*

**Appendix B**  
**List of Acronyms and Glossary**



## List of Acronyms and Glossary

### List of Acronyms

AAR	After-Action Report
CBRNE	Chemical, Biological, Radiological, Nuclear, and High-Yield Explosive
CERT	Community Emergency Response Team
CIKR	Critical Infrastructure and Key Resources
COG	Continuity of Government
CONOPS	Concept of Operations
COOP	Continuity of Operations
CPG	Comprehensive Preparedness Guide
DAP	Disaster Assistance Policy
DHS	U.S. Department of Homeland Security
EAS	Emergency Alert System
EMS	Emergency Medical Services
EOC	Emergency Operations Center
EOP	Emergency Operations Plan
ESF	Emergency Support Function
FEMA	Federal Emergency Management Agency
FOG	Field Operations Guide
HAZMAT	Hazardous Material(s)
HAZUS-MH	Hazards U.S. Multi-Hazard
ICS	Incident Command System
JFO	Joint Field Office
LEPC	Local Emergency Planning Committee
MAA	Mutual Aid Agreement
MOA	Memorandum of Agreement
MOU	Memorandum of Understanding
NIMS	National Incident Management System
NRF	National Response Framework
P.L.	Public Law
SOG	Standard Operating Guideline
SOP	Standard Operating Procedure
RD	Reclamation District
U.S.C.	United States Code

### Glossary

#### **Access and Functional Needs**

Those actions, services, accommodations, and programmatic, architectural, and communication modifications that a covered entity must undertake or provide to afford individuals with disabilities a full and equal opportunity to use and enjoy programs, services, activities, goods, facilities, privileges, advantages, and accommodations in the most integrated setting. These actions are in light of the exigent

B-1 circumstances of the emergency and the legal obligation to undertake advance planning and prepare to meet the disability-related needs of individuals who have disabilities as defined by the

Americans with Disabilities Act Amendments Act of 2008, P.L. 110-325, and those associated with them.

Access and functional needs may include modifications to programs, policies, procedures, architecture, equipment, services, supplies, and communication methods. Examples of “access and functional needs” services may include a reasonable modification of a policy, practice, or procedure or the provision of auxiliary aids and services to achieve effective communication, including but not limited to:

- An exception for service animals in an emergency shelter where there is a no-pets policy
- The provision of way-finding assistance to someone who is blind to orient to new surroundings
- The transferring and provision of toileting assistance to an individual with a mobility disability
- The provision of an interpreter to someone who is deaf and seeks to fill out paperwork for public benefits.

### **American Red Cross**

A nongovernmental humanitarian organization led by volunteers that provides relief to victims of disasters and helps people prevent, prepare for, respond to, and recover from emergencies. The American Red Cross accomplishes this through services that are consistent with its Congressional Charter and the Principles of the International Red Cross Movement.

### **Attack**

A hostile action taken against the United States by foreign forces or terrorists, resulting in the destruction of or damage to military targets, injury or death to the civilian population, or damage to or destruction of public and private property.

### **Capabilities-based Planning**

Planning, under uncertainty, to provide capabilities suitable for a wide range of threats and hazards while working within an economic framework that necessitates prioritization and choice. Capabilities-based planning addresses uncertainty by analyzing a wide range of scenarios to identify required capabilities.

### **Checklist**

Written (or computerized) enumeration of actions to be taken by an individual or organization meant to aid memory rather than provide detailed instruction.

### **Citizen Corps**

A community-based program, administered by FEMA, which includes Citizen Corps councils and other programs that bring government and nongovernmental entities together to conduct all-hazards emergency preparedness and operations. Through its network of state, territorial, tribal and local councils, Citizen Corps increases community preparedness and response capabilities through collaborative planning, public education, outreach, training, and volunteer service. Additionally, programs like the Community Emergency Response Team Program train members of

the public in basic disaster response skills, such as fire safety, light search and rescue, team organization, and disaster medical operations.

### **Community**

Community has more than one definition. Each use depends on the context:

- A political or geographical entity that has the authority to adopt and enforce laws and ordinances for the area under its jurisdiction. In most cases, the community is an incorporated town, city, township, village, or unincorporated area of a county. However, each state defines its own political subdivisions and forms of government.
- A group of individuals (community of interest) who have a religion, a lifestyle, activity interests, an interest in volunteer organizations, or other characteristics in common. These communities may belong to more than one geographic community. Examples include: faith-based and social organizations; nongovernmental and volunteer organizations; private service providers; critical infrastructure operators; and local and regional corporations.

### **Consequence**

An effect of an incident or occurrence.

### **Dam**

A barrier built across a watercourse for the purpose of impounding, controlling, or diverting the flow of water.

### **Damage Assessment**

The process used to appraise or determine the number of injuries and deaths, damage to public and private property, and status of key facilities and services (e.g., hospitals and other health care facilities, fire and police stations, communications networks, water and sanitation systems, utilities, transportation networks) resulting from a human-caused or natural disaster.

### **Disability**

According to the Americans with Disabilities Act, the term “individual with a disability” refers to “a person who has a physical or mental impairment that substantially limits one or more major life activities, a person who has a history or record of such an impairment, or a person who is regarded by others as having such an impairment.” The term “disability” has the same meaning as that used in the Americans with Disabilities Act Amendments Act of 2008, P.L. 110-325, as incorporated into the Americans with Disabilities Act. See <http://www.ada.gov/pubs/ada.htm> for the definition and specific changes to the text of the Americans with Disabilities Act. State laws and local ordinances may also include individuals outside the Federal definition.

### **Disaster**

An occurrence of a natural catastrophe, technological accident, or human-caused incident that has resulted in severe property damage, deaths, and/or multiple injuries. As used in this Guide, a “large-scale disaster” is one that exceeds the response capability of the local jurisdiction and requires state, and potentially Federal, involvement. As used in the Robert T. Stafford Disaster Relief and

Emergency Assistance Act (Stafford Act), a “major disaster” is “any natural catastrophe [...] or, regardless of cause, any fire, flood, or explosion, in any part of the United States, which in the determination of the President causes damage of sufficient severity and magnitude to warrant major disaster assistance under [the] Act to supplement the efforts and available resources of states, local governments, and disaster relief organizations in alleviating the damage, loss, hardship, or suffering caused thereby” (Stafford Act, Sec. 102(2), 42 U.S.C. 5122(2)).

### **Earthquake**

The sudden motion or trembling of the ground produced by abrupt displacement of rock masses, usually within the upper 10 to 20 miles of the earth’s surface.

### **Emergency**

Any incident, whether natural or human-caused, that requires responsive action to protect life or property. Under the Stafford Act, an emergency “means any occasion or instance for which, in the determination of the President, Federal assistance is needed to supplement state and local efforts and capabilities to save lives and to protect property and public health and safety, or to lessen or avert the threat of a catastrophe in any part of the United States” (Stafford Act, Sec. 102(1), 42 U.S.C. 5122(1)).

### **Emergency Assistance**

According to the National Response Framework, emergency assistance is “[a]ssistance required by individuals, families, and their communities to ensure that immediate needs beyond the scope of the traditional ‘mass care’ services provided at the local level are addressed. These services include: support to evacuations (including registration and tracking of evacuees); reunification of families; provision of aid and services to special needs populations; evacuation, sheltering, and other emergency services for household pets and services animals; support to specialized shelters; support to medical shelters; nonconventional shelter management; coordination of donated goods and services; and coordination of voluntary agency assistance.”

### **Emergency Medical Services**

Services, including personnel, facilities, and equipment, required to ensure proper medical care for the sick and injured from the time of injury to the time of final disposition (which includes medical disposition within a hospital, temporary medical facility, or special care facility; release from the site; or being declared dead). Further, emergency medical services specifically includes those services immediately required to ensure proper medical care and specialized treatment for patients in a hospital and coordination of related hospital services.

### **Emergency Operations Center**

The physical location at which the coordination of information and resources to support incident management (on-scene operations) activities normally takes place. An Emergency Operations Center may be a temporary facility or may be located in a more central or permanently established facility, perhaps at a higher level of organization within a jurisdiction. Emergency Operations Centers may be organized by major functional disciplines (e.g., fire, law enforcement, medical services), by jurisdiction (e.g., Federal, state, tribal, regional, city, county), or by some combination thereof.

## **Emergency Operations Plan**

The ongoing plan maintained by various jurisdictional levels for responding to a wide variety of potential hazards. It describes how people and property will be protected; details who is responsible for carrying out specific actions; identifies the personnel, equipment, facilities, supplies, and other resources available; and outlines how all actions will be coordinated.

## **Emergency Support Function**

Used by the Federal Government and many state governments as the primary mechanism at the operational level to organize and provide assistance. Emergency Support Functions align categories of resources and provide strategic objectives for their use. Emergency Support Functions use standardized resource management concepts such as typing, inventorying, and tracking to facilitate the dispatch, deployment, and recovery of resources before, during, and after an incident.

## **Evacuation**

The organized, phased, and supervised withdrawal, dispersal, or removal of civilians from dangerous or potentially dangerous areas, and their reception and care in safe areas.

- A spontaneous evacuation occurs when residents or citizens in the threatened areas observe an incident or receive unofficial word of an actual or perceived threat and, without receiving instructions to do so, elect to evacuate the area. Their movement, means, and direction of travel are unorganized and unsupervised.
- A voluntary evacuation is a warning to persons within a designated area that a threat to life and property exists or is likely to exist in the immediate future. Individuals issued this type of warning or order are not required to evacuate; however, it would be to their advantage to do so.
- A mandatory or directed evacuation is a warning to persons within the designated area that an imminent threat to life and property exists and individuals must evacuate in accordance with the instructions of local officials.

## **Evacuees**

All persons removed or moving from areas threatened or struck by a disaster.

## **Federal Coordinating Officer**

The official appointed by the President to execute Stafford Act authorities, including the commitment of FEMA resources and mission assignments of other Federal departments or agencies. In all cases, the Federal Coordinating Officer represents the FEMA Administrator in the field to discharge all FEMA responsibilities for the response and recovery efforts underway. For Stafford Act incidents, the Federal Coordinating Officer is the primary Federal representative with whom the State Coordinating Officer and other response officials interface to determine the most urgent needs and to set objectives for an effective response in collaboration with the Unified Coordination Group.

## **Flood**

A general and temporary condition of partial or complete inundation of normally dry land areas from overflow of inland or tidal waters, unusual or rapid accumulation or runoff of surface waters, or mudslides/mudflows caused by accumulation of water.

## **Governor's Authorized Representative**

An individual empowered by a Governor to: (1) execute all necessary documents for disaster assistance on behalf of the state, including certification of applications for public assistance; (2) represent the Governor of the impacted state in the Unified Coordination Group, when required; (3) coordinate and supervise the state disaster assistance program to include serving as its grant administrator; and (4) identify, in coordination with the State Coordinating Officer, the state's critical information needs for incorporation into a list of Essential Elements of Information.

## **Hazard**

A natural, technological, or human-caused source or cause of harm or difficulty.

## **Hazardous Material**

Any substance or material that, when involved in an accident and released in sufficient quantities, poses a risk to people's health, safety, and/or property. These substances and materials include explosives, radioactive materials, flammable liquids or solids, combustible liquids or solids, poisons, oxidizers, toxins, and corrosive materials.

## **Household Pet**

According to FEMA Disaster Assistance Policy 9253.19, "[a] domesticated animal, such as a dog, cat, bird, rabbit, rodent, or turtle, that is traditionally kept in the home for pleasure rather than for commercial purposes, can travel in commercial carriers, and be housed in temporary facilities. Household pets do not include reptiles (except turtles), amphibians, fish, insects/arachnids, farm animals (including horses), and animals kept for racing purposes." This definition is used by FEMA to determine assistance that FEMA will reimburse and is the definition used in the production of this Guide. Individual jurisdictions may have different definitions based on other criteria.

## **Hurricane**

A tropical cyclone, formed in the atmosphere over warm ocean areas, in which wind speeds reach 74 miles per hour or more and blow in a large spiral around a relatively calm center or eye. Circulation is counter-clockwise in the Northern Hemisphere and clockwise in the Southern Hemisphere.

## **Incident**

An occurrence or event—natural, technological, or human-caused—that requires a response to protect life, property, or the environment (e.g., major disasters, emergencies, terrorist attacks, terrorist threats, civil unrest, wildland and urban fires, floods, hazardous materials spills, nuclear accidents, aircraft accidents, earthquakes, hurricanes, tornadoes, tropical storms, tsunamis, war-

related disasters, public health and medical emergencies, other occurrences requiring an emergency response).

### **Incident Command System**

A standardized on-scene emergency management construct specifically designed to provide an integrated organizational structure that reflects the complexity and demands of single or multiple incidents, without being hindered by jurisdictional boundaries. The Incident Command System is the combination of facilities, equipment, personnel, procedures, and communications operating within a common organizational structure and designed to aid in the management of resources during incidents. It is used for all kinds of emergencies and is applicable to small, as well as large and complex, incidents. The Incident Command System is used by various jurisdictions and functional agencies, both public and private, to organize field-level incident management operations.

### **Incident Management Assistance Team**

A national-based or regional-based team composed of SMEs and incident management professionals, usually composed of personnel from multiple Federal departments and agencies, which provide incident management support during a major incident.

### **Joint Field Office**

The primary Federal incident management field structure. The Joint Field Office is a temporary Federal facility that provides a central location for the coordination of Federal, state, territorial, tribal, and local governments and private sector and nongovernmental organizations with primary responsibility for response and recovery. The Joint Field Office structure is organized, staffed, and managed in a manner consistent with National Incident Management System principles and is led by the Unified Coordination Group. Although the Joint Field Office uses an Incident Command System structure, the Joint Field Office does not manage on-scene operations. Instead, the Joint Field Office focuses on providing support to on-scene efforts and conducting broader support operations that may extend beyond the incident site.

### **Joint Information Center**

A facility established to coordinate all incident-related public information activities. It is the central point of contact for all news media. Public information officials from all participating agencies should co-locate at the Joint Information Center.

### **Jurisdiction**

Jurisdiction has more than one definition. Each use depends on the context:

- A range or sphere of authority. Public agencies have jurisdiction at an incident related to their legal responsibilities and authority. Jurisdictional authority at an incident can be political or geographical (e.g., city, county, tribal, state, or Federal boundary lines) or functional (e.g., law enforcement, public health).
- A political subdivision (e.g., Federal, state, county, parish, municipality) with the responsibility for ensuring public safety, health, and welfare within its legal authorities and geographic boundaries.

**Likelihood**

Estimate of the potential for an incident's occurrence.

**Limited English Proficiency**

Persons who do not speak English as their primary language and who have a limited ability to read, speak, write, or understand English.

**Mass Care**

The actions that are taken to protect evacuees and other disaster victims from the effects of the disaster. Activities include mass evacuation, mass sheltering, mass feeding, access and functional needs support, and household pet and service animal coordination.

**Mitigation**

Activities providing a critical foundation in the effort to reduce the loss of life and property from natural and/or human-caused disasters by avoiding or lessening the impact of a disaster and providing value to the public by creating safer communities. Mitigation seeks to fix the cycle of disaster damage, reconstruction, and repeated damage. These activities or actions, in most cases, will have a long-term sustained effect.

**National Incident Management System**

A set of principles that provides a systematic, proactive approach guiding government agencies at all levels, nongovernmental organizations, and the private sector to work seamlessly to prevent, protect against, respond to, recover from, and mitigate the effects of incidents, regardless of cause, size, location, or complexity, in order to reduce the loss of life or property and harm to the environment.

**National Response Framework**

This document establishes a comprehensive, national, all-hazards approach to domestic incident response. It serves as a guide to enable responders at all levels of government and beyond to provide a unified

B- national response to a disaster. It defines the key principles, roles, and structures that organize the way U.S. jurisdictions plan and respond.

**Nongovernmental Organization**

An entity with an association that is based on the interests of its members, individuals, or institutions. It is not created by a government, but it may work cooperatively with government. Such organizations serve a public purpose and are not for private benefit. Examples of nongovernmental organizations include faith-based charity organizations and the American Red Cross.

**Planning Assumptions**

Parameters that are expected and used as a context, basis, or requirement for the development of response and recovery plans, processes, and procedures. If a planning assumption is not valid for a specific incident's circumstances, the plan may not be adequate to ensure response success.

Alternative methods may be needed. For example, if a decontamination capability is based on the



planning assumption that the facility is not within the zone of release, this assumption must be verified at the beginning of the response.

### **Preparedness**

Actions that involve a combination of planning, resources, training, exercising, and organizing to build, sustain, and improve operational capabilities. Preparedness is the process of identifying the personnel, training, and equipment needed for a wide range of potential incidents, and developing jurisdiction-specific plans for delivering capabilities when needed for an incident.

### **Prevention**

Actions to avoid an incident or to intervene to stop an incident from occurring. Prevention involves actions to protect lives and property. It involves applying intelligence and other information to a range of activities that may include such countermeasures as deterrence operations; heightened inspections; improved surveillance and security operations; investigations to determine the full nature and source of the threat; public health and agricultural surveillance and testing processes; immunizations, isolation, or quarantine; and, as appropriate, specific law enforcement operations aimed at deterring, preempting, interdicting, or disrupting illegal activity and apprehending potential perpetrators and bringing them to justice.

### **Protected Group**

A group of people qualified for special protection by a law, policy, or similar authority. For example, Title VI of the Civil Rights Act of 1964 protects against discrimination on the grounds of race, color, or national origin.

### **Protection**

Actions to reduce or eliminate a threat to people, property, and the environment. Primarily focused on adversarial incidents, the protection of critical infrastructure and key resources is vital to local jurisdictions, national security, public health and safety, and economic vitality. Protective actions may occur before, during, or after an incident and prevent, minimize, or contain the impact of an incident.

### **Recovery**

The development, coordination, and execution of service and site restoration plans; the reconstitution of government operations and services; individual, private sector, nongovernmental, and public assistance programs to provide housing and to promote restoration; long-term care and treatment of affected persons; additional measures for social, political, environmental, and economic restoration; evaluation of the incident to identify lessons learned; post-incident reporting; and development of initiatives to mitigate the effects of future incidents.

### **Resource Management**

A system for identifying available resources at all jurisdictional levels to enable timely, efficient, and unimpeded access to resources needed to prepare for, respond to, or recover from an incident. Resource management under the National Incident Management System includes mutual aid and assistance agreements; the use of special Federal, state, territorial, tribal, and local teams; and resource mobilization protocols.

**Response**

Immediate actions to save and sustain lives, protect property and the environment, and meet basic human needs. Response also includes the execution of plans and actions to support short-term recovery.

**Risk**

The potential for an unwanted outcome resulting from an incident or occurrence, as determined by its likelihood and the associated consequences.

**Risk Analysis**

A systematic examination of the components and characteristics of risk.

**Risk Assessment**

A product or process that collects information and assigns values to risks for the purpose of informing priorities, developing or comparing courses of action, and informing decision making.

**Risk Identification**

The process of finding, recognizing, and describing potential risks.

**Risk Management**

The process of identifying, analyzing, assessing, and communicating risk and accepting, avoiding, transferring, or controlling it to an acceptable level at an acceptable cost.

**Scenario**

Hypothetical situation composed of a hazard, an entity impacted by that hazard, and associated conditions including consequences when appropriate.

**Scenario-based Planning**

A planning approach that uses a hazard vulnerability assessment to assess the hazard's impact on an organization on the basis of various threats that the organization could encounter. These threats (e.g., hurricane, terrorist attack) become the basis of the scenario.

**Senior Official**

The elected or appointed official who, by statute, is charged with implementing and administering laws, ordinances, and regulations for a jurisdiction. He or she may be a mayor, city manager, etc.

**Service Animal**

Any guide dog, signal dog, or other animal individually trained to assist an individual with a disability. Service animals' jobs include, but are not limited to:

- Guiding individuals with impaired vision
- Alerting individuals with impaired hearing (to intruders or sounds such as a baby's cry, the doorbell, and fire alarms)

- Pulling a wheelchair
- Retrieving dropped items
- Alerting people of impending seizures
- Assisting people who have mobility disabilities with balance or stability.

### **Standard Operating Procedure/Guideline**

A reference document or operations manual that provides the purpose, authorities, duration, and details for the preferred method of performing a single function or a number of interrelated functions in a uniform manner.

### **State Coordinating Officer**

The individual appointed by the Governor to coordinate state disaster assistance efforts with those of the Federal Government. The State Coordinating Officer plays a critical role in managing the state response and recovery operations following Stafford Act declarations. The Governor of the affected state appoints the State Coordinating Officer, and lines of authority flow from the Governor to the State Coordinating Officer, following the state's policies and laws.

### **Storm Surge**

A dome of sea water created by strong winds and low barometric pressure in a hurricane that causes severe coastal flooding as the hurricane strikes land.

### **Terrorism**

Activity that involves an act that is dangerous to human life or potentially destructive of critical infrastructure or key resources; is a violation of the criminal laws of the United States or of any state or other subdivision of the United States; and appears to be intended to intimidate or coerce a civilian population, to influence the policy of a government by intimidation or coercion, or to affect the conduct of a government by mass destruction, assassination, or kidnapping.

### **Tornado**

A local atmospheric storm, generally of short duration, formed by winds rotating at very high speeds, usually in a counter-clockwise direction. The vortex, up to several hundred yards wide, is visible to the observer as a whirlpool-like column of winds rotating about a hollow cavity or funnel. Winds can be as low as 65 miles per hour, but may reach 300 miles per hour or higher.

### **Tsunami**

Sea waves produced by an undersea earthquake. Such sea waves can reach a significant height resulting in damage or devastation to coastal cities and low-lying coastal areas.

### **Uncertainty**

The degree to which a calculated, estimated, or observed value may deviate from the true value.

### **Vulnerability**

A physical feature or operational attribute that renders an entity open to exploitation or susceptible to a given hazard.

**Warning**

The alerting of emergency response personnel and the public to the threat of extraordinary danger and the related effects that specific hazards may cause.

**Appendix C**  
**Description of Levee Sections**

**Pico Naglee Tract - RD1007  
Description of Levee Sections**

Section	Start (Station)	End (Station)	Levee Description	Conditions	Crown Condition
1	0+00	48+00	<b>Tom Paine Slough:</b> Station 0+00 starts along the west side of Sugar Cut at convergence of Sugar Cut and Tom Paine Slough. The stationing continues north along the west bank of Tom Paine Slough to station 48+00. Approximately 0.9 miles.	The toe of this levee is high (Elev 12'). The Slough is narrow and shallow which limits the amount of flow and wind. The landside is comprised of alluvial sands and has minimal peat deposits.	The levee is about 30' in width at an elevation from 24.4' to 28.8'. The levee crown has all weather road surface.
2	48+00	172+00	<b>Tom Paine Slough / Old River:</b> Station 48+00 starts at the convergence of Old River and Tom Paine Slough. The stationing continues west along Old River to the Bridge over the Old River to station 170+00. Approximately 2.3 miles.	As the levee proceeds west, the toe drops slightly (Elev 8'). The River is narrow and shallow which limits the amount of flow and wind. The landside is comprised of alluvial sands and has minimal peat deposits.	The levee is about 30' in width at an elevation from 19.6' to 24.7'. The levee crown has all weather road surface.
3	172+00	260+00	<b>Old River:</b> Station 170+00 starts at the Bridge crossing over Old River. The stationing continues west to station 260+00. Approximately 1.7 miles	As the levee proceeds west, the toe holds elevation (Elev 8'). The River gets wider and more susceptible to winds from the North. There are areas of little waterside rock protection and highly vegetated waterside slope.	The levee is about 22' in width at an elevation from 18.6' to 22.0'. The levee crown has all weather road surface.
4	260+00	446+00	<b>Old River:</b> Station 260+00 starts along Old River. The stationing continues west towards the convergence of WID Canal and Old River at station 446+00. Approximately 3.5 miles.	This section of levee has a lower toe compared to the rest of the levee sections (Elev 4). There are areas of little waterside rock protection and highly vegetated waterside slope.	The levee is about 22' in width at an elevation from 17.2' to 22.3'. The levee crown has all weather road surface. This section has levee encroachments on the crown of the levee. Access is limited in some locations (see map). Stations 330+00 to 350+00 are 10' in width.

**Appendix D**  
**Siphon Inventory and Levee Sections Map**

# PICO NAGLEE TRACT RECLAMATION DISTRICT 1007

LEGEND	DESCRIPTION
	IRRIGATION PUMP NUMBER AND LOCATION SEE IRRIGATION PUMP INVENTORY TABLE
	*LEVEE SECTION 1 (STATION 0+00 TO 106+00)
	*LEVEE SECTION 2 (STATION 106+00 TO 446+00)
*SEE DESCRIPTION OF LEVEE SECTIONS (APPENDIX C)	

IRRIGATION PUMP INVENTORY TABLE:	
STATION	#PUMPS & HP
1. 48+00	1 - 25HP
2. 88+00	2 - 25HP
3. 265+00	1 - 25HP
4. 293+00 (MAIN PUMPS)	1 - 50HP 1 - 40HP 1 - 15HP
5. 328+00	1 - 30HP
6. 410+00	1 - 15HP

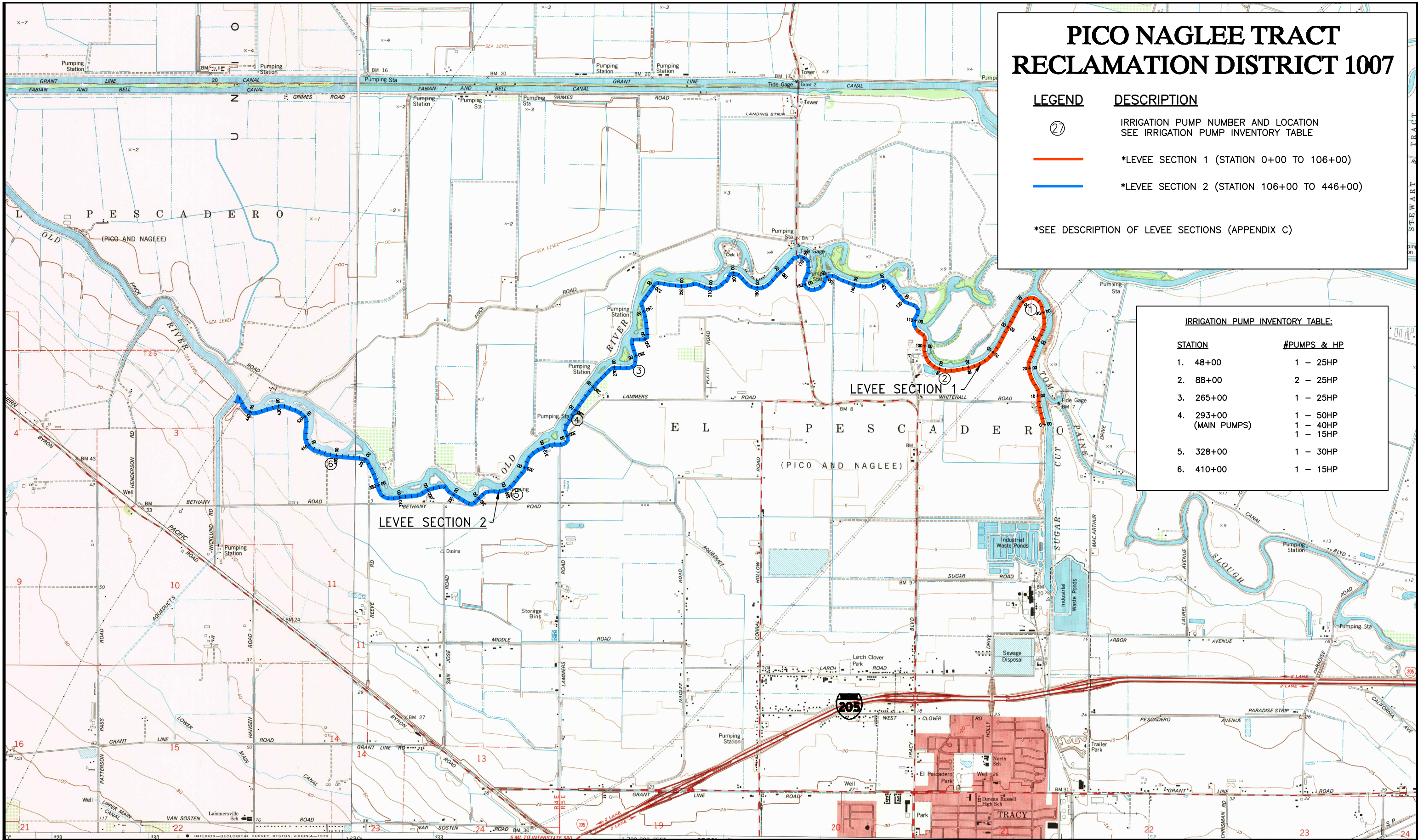

SCALE: 1"=3000'

REVISIONS		
REV.	DATE	DESCRIPTION



PICO NAGLEE TRACT  
RECLAMATION DISTRICT 1007  
IRR. PUMP INVENTORY & LEVEE SECTIONS MAP  
RECLAMATION DISTRICT NO 2072  
WOODWARD TRACT, CALIFORNIA

PROJECT NO:	1007-30	SHEET NO.	E-1
DRAWN BY:	GME	OF	1
DESIGN BY:	SJB	SHEETS	1
CHECK BY:	DG		
SCALE:	AS SHOWN		
DATE:	2015		
CAD FILE:	SIPHON INVENTORY & LEVEE SECTIONS MAP.DWG		



**Appendix E**  
**Emergency Response and Training Policy**

## Reclamation District No. 1007 Emergency Response and Training Policy

Reclamation District No. 1007 Board of Trustees hereby adopts the National Incident Management System (NIMS) for organizing emergency response activities. The Board further establishes the following emergency response and training policies.

### Emergency Response

In an emergency, the District Board of Trustees is responsible for determining general response policy and performing financial oversight. The District Incident Commander is responsible for organizing District response activities, supervising any hired staff or contractors working for the District, and for coordinating with outside agencies. The District hereby establishes the position of Emergency Levee Worker for purposes of hiring or re-assigning non-District staff for levee patrol or other flood fighting tasks at the time of the emergency.

### National Incident Management System Training Guidance

In regard to meeting national training requirements, the District will comply with the provisions of the National Incident Management System Training Program Manual, September 2011 and any subsequent revisions to that document. The District will also comply with California Standardized Emergency Management System (SEMS) training requirements.

The NIMS Training Program Manual indicates that federal training guidance is not absolute and that organizations should tailor their training to the level of incident complexity that their staff would potentially manage. After careful review of the definitions of incident complexity levels shown on Page 16 of the NIMS Training Program Manual, this Board has determined that District responsibilities to patrol its levees and respond to threats to levee structural integrity would require District staff to manage Type 4 incidents. District training requirements outlined below meet NIMS training recommendations for Type 4 incidents (pages 17 and 18, NIMS Training Program Manual, September 2011) and SEMS training requirements.

### Reclamation District No. 1007 Training Requirements

The Board of Trustees hereby establishes the following training requirements for District staff involved in flood emergency operations.

Members of the Board of Trustees and District Secretary shall complete the G-402, Incident Command System Overview for Executives and Senior Officials and the SEMS Executive Course.

The District Engineer and appropriate staff who may serve in the District response organization shall complete, at a minimum, the SEMS Introduction, ICS-100 Introduction to

the Incident Command System, ICS-200 ICS for Single Resources and Initial Action Incidents, and IS-700 NIMS An Introduction courses to meet Type 4 incident management requirements. In addition, the District Engineer shall complete IS-800 National Response Framework and IS-701 NIMS MACS course to meet inter-agency coordination responsibilities.

Staff hired or transferred to serve as Emergency Levee Workers at the time of an emergency shall receive a 2-hour RD1007 Emergency Safety and NIMS Course that will include a 60 minute summary of the SEMS Introduction, ICS-100 and IS-700 courses and 60 minutes of specific safety and procedures information for their emergency duties prior to beginning work.

This policy is hereby approved by the Board of Trustees on \_\_\_\_\_.

\_\_\_\_\_

Trustee and President

\_\_\_\_\_

Trustee

\_\_\_\_\_

Trustee

**Appendix F**  
**Delegation of Authority Letter**

# Reclamation District No. 1007 Delegation of Authority Letter

As of \_\_\_\_\_ hrs, \_\_\_\_\_, I have delegated the authority and responsibility for the  
(Time) (Date)

complete management of the Reclamation District 1007 \_\_\_\_\_ Incident to  
(Name of Incident)

\_\_\_\_\_ acting as District Incident  
(Name of Individuals)

Commander and Deputy Incident Commander respectively.

### Instructions

As Incident and Deputy Commander, you are accountable to me and the Board of Trustees for the overall management of this incident including control and supervision over District staff and contractors. I expect you to adhere to relevant and applicable laws, policies, and professional standards.

My general considerations for management of the incident are:

1. Provide for safety of District staff.
2. Keep the Board and District Secretary informed of key actions, and the situation.
3. Comply with the RD1007 Flood Safety Plan and document conditions requiring its modification

My specific directions and clarifications of authority for this incident are:

- 1.
- 2.
- 3.

By: \_\_\_\_\_  
(President, Board of Trustees)

\_\_\_\_\_  
Date

**Appendix G**  
**Standard Contract Form**

**CONTRACT FORM**

This agreement, made and entered this \_\_\_\_\_ day of \_\_\_\_\_, YEAR, by and between Reclamation District No. 1007, hereinafter DISTRICT, and \_\_\_\_\_, hereinafter CONTRACTOR.

For and in consideration of the payments hereinafter specified to be made by DISTRICT, CONTRACTOR agrees at its own proper cost and expense, to do and/or provide the following in accordance with applicable plans and specifications and as directed by DISTRICT:

PROJECT DESCRIPTION DETAILS and PROPOSAL SUBMITTED by CONTRACTOR, Exhibit A.

The total agreed upon price: NOT TO EXCEED AMOUNT based on unit prices.

Payment shall be made within sixty (60) days after acceptance of work or portions thereof by DISTRICT or as follows: \_\_\_\_\_

\_\_\_\_\_  
\_\_\_\_\_

CONTRACTOR shall provide DISTRICT with payment bond in the amount of \_\_\_\_\_ in accordance with Civil Code Sections 3247 through 3258. No payment will be made by DISTRICT until such bond has been received.

CONTRACTOR shall provide DISTRICT with performance bond in the amount of \_\_\_\_\_ guaranteeing faithful performance of said contract.

The complete Contract between the DISTRICT and CONTRACTOR shall consist of the following component parts, to-wit: This instrument; the NOTICE INVITING BIDS; the addenda, if any; the accepted Bid Schedule, including all required attached documents; the required bond(s) fully executed; and each of the component parts of the "EMERGENCY REPAIR PROJECT," dated MONTH AND YEAR.

This instrument and the other documents mentioned above constitute the complete Contract between the DISTRICT and CONTRACTOR and the said other documents are as fully a part of this Contract as if hereto attached or herein repeated.

As used herein, "INDEMNIFIED PARTIES" collectively refers to all the following: DISTRICT and its board of trustees, officers, agents and employees; and the State of California, and all of its agencies, departments, officers, agents and employees, including but not limited to the Central Valley Flood Protection Board and the Department of Water Resources and their respective officers, agents and employees.

CONTRACTOR shall be responsible for its own work, property, and/or materials until completion and final acceptance of the work by the DISTRICT. In the event of loss or damage, it shall proceed promptly to make repairs or replacement of the damaged work, property, and/or materials at its own expense, as directed by the DISTRICT. CONTRACTOR waives all rights CONTRACTOR might have against DISTRICT for loss of or damage to CONTRACTOR's work, property, or materials. Payment shall not be construed as a waiver of this or of any other terms of the Contract.

CONTRACTOR shall pay for all material, labor, taxes, insurance and other claims, liabilities, and obligations of any nature arising from any aspect of its work performed under this Contract, and shall furnish satisfactory evidence of such payments upon request of DISTRICT. CONTRACTOR agrees to indemnify, defend, and hold harmless INDEMNIFIED PARTIES from all suits, liens, or other claims of any nature arising from its failure to make such payments.

CONTRACTOR shall provide and maintain at all times during the performance the following insurance:

Workers' Compensation insurance meeting the requirements of both the State of California and the Federal Longshore and Harbor Workers' Compensation Act to the extent applicable.

Insurance covering Public Liability, Property Damage, and Contractor's Contractual Liability arising out of or relating to CONTRACTOR's performance hereunder (all including but not limited to work performance and the operation of automobiles, trucks and other vehicles) in amounts of not less than \$1,000,000 per occurrence, protecting CONTRACTOR and INDEMNIFIED PARTIES against liability for damages because of injuries (including death) and in an amount of not less than \$1,000,000 per occurrence against liability for damages to property. All of the following shall be named as additional insureds on said policies: "Reclamation District No. X and its board of trustees, officers, agents and employees; and the State of California, and all of its agencies, departments, officers, agents and employees."

All insurance required hereunder shall be maintained in full force and effect in a company or companies satisfactory to DISTRICT, shall be maintained at CONTRACTOR's expense until performance in full hereof and such insurance shall be subject to requirement that DISTRICT must be notified by thirty (30) days' written notice before cancellation of any such policy. In the event of threatened cancellation for non-payment of premium, DISTRICT may pay same for CONTRACTOR and deduct the same payment from amounts then or subsequently owing to CONTRACTOR hereunder.

Evidence of such insurance shall be furnished by CONTRACTOR to DISTRICT upon request.

CONTRACTOR specifically obligates itself to DISTRICT in the following respects (and this agreement is made upon such express condition), to wit:  
for any cost, expense or judgment (including attorney's fees) paid or incurred in that behalf.

CONTRACTOR shall be fully and exclusively responsible for and shall pay when due any and all applicable contributions, allowances or other payments or deductions, however termed, required by union labor agreements now or hereafter in force.

CONTRACTOR shall indemnify INDEMNIFIED PARTIES against, and save them harmless from any and all loss, damage, costs, expenses and attorney's fees suffered or incurred on account of any breach of the aforesaid obligations and covenants, and any other provisions or covenants of this Contract.

At any time before final settlement or adjudication of any loss, damage, liability, claim, demand, suit or cause of action for which CONTRACTOR hereby agrees to indemnify and save



INDEMNIFIED PARTIES harmless, DISTRICT may withhold from any payments due or to become due under this Contract the reasonable value thereof, as determined by DISTRICT.

CONTRACTOR specifically agrees that it is, or prior to the start of work hereunder will become, a CONTRACTOR and an employing unit subject as an employer, to all applicable Unemployment Compensation Statutes.

CONTRACTOR further agrees as regards, (a) the production, purchase and sale, furnishing and delivering, pricing, and use or consumption of materials, supplies and equipment, (b) the hire, tenure or conditions of employment of employees and their hours of work and rates of and the payment of their wages, and (c) the keeping of records, making of reports, and the payment, collection, and/or deduction of Federal, State and Municipal taxes and contributions that CONTRACTOR will keep and have available all necessary records and make all payments, reports, collections, deductions, and otherwise do any and all things so as to fully comply with all Federal, State and Municipal laws, ordinances, regulations, and requirements in regard to any and all said matters insofar as they affect or involve the CONTRACTOR's performance of this Contract, all so as to fully relieve INDEMNIFIED PARTIES from and protect it against any and all responsibility or liability therefore or in regard thereto.

CONTRACTOR shall protect and keep INDEMNIFIED PARTIES harmless and free from all liability, penalties, losses, damages, costs, expenses, causes of action, claims and judgments resulting from injury or harm to any person or property arising out of or in any way connected with the performance hereof.

CONTRACTOR shall further hold INDEMNIFIED PARTIES harmless from liability or claims for any injuries to or death of CONTRACTOR's employees resulting from any cause whatsoever, and shall indemnify INDEMNIFIED PARTIES

CONTRACTOR further agrees as to comply with California Labor Codes including, but not limited to:

Pursuant to Labor Code Section 1771 for contracts over \$1,000.00, this district works with the Compliance Monitoring Unit/Division of Labor Standards Enforcement and requires that all contractors and subcontractors working on this project keep certified payroll records in accordance with Labor Code Section 1776, and to submit electronically via the Department of Industrial Relations (DIR) Compliance Monitoring Unit website. For any questions please email [CMU@dir.ca.gov](mailto:CMU@dir.ca.gov) or call 916-263-1811.

Pursuant to Labor Code Section 1771.1, a contractor or subcontractor shall not be qualified to bid on, be listed in a bid proposal, subject to the requirements of Section 4104 of the Public Contract Code, or engage in the performance of any contract for public work, unless currently registered and qualified to perform public work pursuant to Section 1725.5.

In accordance with the provisions of Labor Code Section 1720 et seq., the Division of Labor Standards and Research has determined the general prevailing rates or wages and employer payments for health and welfare, pension, vacation, travel time, and subsistence pay as provided for in Labor Code Section 1773.8.

It shall be mandatory upon the CONTRACTOR herein and upon any Subcontractor to pay not less than the said specified rates to all laborers, workers, and mechanics employed by them in the execution of the Agreement pursuant to Labor Code Section 1774.

The CONTRACTOR shall post job site notices, as prescribed by regulation 1771.4(a)(2).

The District or District Representative shall make periodic site visits to observe and interview workers regarding the payment of prevailing wages and proper work classifications. Contractor and each Subcontractor shall cooperate and coordinate with the District and provide unaccompanied access to workers on the job site.

Attention is directed to the provisions in section 1777.5 and sections 1777.6 of the Labor Code concerning the requirement to employ apprentices by the CONTRACTOR or any Subcontractor under it.

Contractors and any Subcontractors shall be assessed penalties for violating labor code sections as stated above and as specified in the labor code.

CONTRACTOR certifies that he is aware of the provisions of Section 3700 of the Labor Code which require every employer to be insured against liability for workers' compensation or to undertake self-insurance in accordance with the provisions of that code, and that he will comply with such provisions before commencing the performance of the work of this Contract.

This agreement shall not be modified except by written document executed by the parties hereto.

CONTRACTOR

RECLAMATION DISTRICT No. 1007

By: \_\_\_\_\_

By: \_\_\_\_\_

Title: \_\_\_\_\_

Title: \_\_\_\_\_

## APPENDIX A

The federal and state labor law requirements applicable to the contract are composed of but not limited to the following items:

1. The contractor's duty to pay prevailing wages under Labor Code Section 1770 et seq., should the project exceed the exemption amounts.
2. The contractor's duty to employ registered apprentices on the public works project under Labor Code Section 1777.5.
3. The penalties for failure to pay prevailing wages (for non-exempt projects) and employ apprentices including forfeitures and debarment under Labor Code Sections 1775 and 1777.7.
4. The requirement to keep and submit copies upon request of certified payroll records under Labor Code Section 1776, and penalties for failure to do so under Labor Code Section 1776(g).
5. The prohibition against employment discrimination under Labor Code Section 1777.6; the Government Code, and Title VII of the Civil Rights Act of 1964.
6. The prohibition against accepting or extracting kickback from employee wages under Labor Code Section 1778.
7. The prohibition against accepting fees for registering any person for public work under Labor Code Section 1779, or for filling work orders on public works under Labor Code Section 1780.
8. The requirement to list all subcontractors under Public Contracts Code Section 4104.
9. The requirement to be properly licensed and to require all subcontractors to be properly licensed and the penalty for employing workers while unlicensed under Labor Code Section 1021 and under the California Contractors License Law, found at Business and Professions Code Section 7000 et seq.
10. The prohibition against unfair competition under Business and Professions Code Section 17200-17208.
11. The requirement that the contractor be properly insured for Workers Compensation under Labor Code Section 1861.
12. The requirement that the contractor abide by the Occupational, Safety and Health laws and regulations that apply to the particular construction project.
13. The federal prohibition against hiring undocumented workers, and the requirement to secure proof of eligibility/citizenship from all workers.
14. The requirement to provide itemized wage statements to employees under Labor Code Section 226.

**Appendix H**  
**Emergency Resolution Template**

**RESOLUTION OF THE BOARD OF TRUSTEES  
OF RECLAMATION DISTRICT NO. 1007  
(Pico Naglee Tract)  
EMERGENCY MEETING DATE: \_\_\_\_\_**

**RESOLUTION No.**

Upon special notice to and consent by the Trustees of Reclamation District No. 1007 (District), of the County of San Joaquin, State of California, an emergency meeting of the Board of Trustees was held at the district office at 4600 S. Tracy Blvd, Ste. 114, Tracy, CA on **[DAY and DATE]** at **[TIME]**. The Board agreed that an emergency situation exists which requires immediate action by the District

**[DESCRIPTION OF EMERGENCY EVENT, JUSTIFICATION]**

**EMERGENCY DECLARATION**

WHEREAS, the trustees of Reclamation District 1007 have considered the condition of the District Levees and the potential risk of general operation at the expense of public safety and agricultural production; and

WHEREAS, the Trustees have noted that the Sacramento and San Joaquin Delta is and will continue to experience high water levels resulting from heavy rainfalls and runoff, high tides, and high winds; and

WHEREAS, the District is experiencing **[DESCRIPTION OF EMERGENCY EVENT]**;  
and

WHEREAS, after consultation with the District Engineers and after a visual assessment of the condition of the District levees on **[DATE(S) and TIME(S)]**, the District found and declared on **[DATE]** that an emergency situation existed and that all necessary and required work to protect the District and the District's levees should be completed at the earliest possible date.

NOW, THEREFORE, BE IT RESOLVED AND ORDERED by the Board of Trustees of the Reclamation District No. 1007, as follows:

1. As of **[DATE]** an emergency situation exists within the District and along the District's levees, which requires the District to proceed immediately with the work to prevent the possible flooding of the district, and failure to its levees at the earliest possible time.
2. That the emergency condition will not permit a delay resulting from a competitive solicitation for bids for securing materials and equipment needed to address the emergency.

3. That the District President, and/or District Engineer be hereby authorized and directed to acquire such materials and equipment and to enter into contracts necessary and appropriate to meet the emergency needs of the district, without observing the need to seek formal competitive solicitation of bids, or bonding.

### **CERTIFICATION**

I, **[NAME]**, President and trustee for Reclamation District No. 1007 do hereby certify that the above is a true and correct copy of the resolution which the Board of Trustees of the District unanimously adopted on **[DATE]**.

Executed on \_\_\_\_\_, in Stockton, California.

\_\_\_\_\_  
**[NAME]**, District President

**Appendix I**  
**Regulatory Notification Template**



- Surveying
- Civil Engineering
- Permitting
- Estimating
- Construction Consulting

**Mail:** 1314 Paloma Avenue  
Stockton, CA 95209  
**Office:** 5665 Pershing Ave, Ste. B-1  
Stockton, CA 95207  
**Phone:** 209-478-6525  
**Fax:** 209-478-6540

## EMERGENCY NOTIFICATION

**DATE:**

**TO:** John Paasch, Chief: Flood Operations Branch: DWR Division of Flood Management  
John Vieira, President, Trustee: RD 1007

**FROM:** Dominick Gulli, District Engineer: RD 1007

**SUBJECT:** Reclamation District No. 1007: Emergency Notification  
Request for Regulatory Coordination Support

Mr. Paasch,

Reclamation District No. 1007, Pico Naglee Tract, is preparing for an eminent emergency situation. Depending on changes in weather and river conditions, the District shall declare that there is an emergency situation that may threaten the District's ability to provide flood protection. The District is formally requesting the support of the Flood Operations Branch Chief of the California Department of Water Resources to support the District efforts to notify all required regulatory agencies to satisfy state and federal notification requirements. It is the intent of the District to prepare for and flood fight any and all incidents that may arise during this pending emergency situation.

The Notification that is being requested by the District should satisfy the regulatory agencies request to provide sufficient time to respond to the pending actions. Depending on conditions, and willingness of the responding regulatory agencies, representatives may be able to access the District levees along with the District Incident Commander or District Engineer to assess the flood fight preparations or potential ongoing activities. The representative must be properly equipped with suitable supplies and equipment to be prepared for on-site conditions. Contact me immediately for any information at (209) 478-6525 or (209) 649-4555.

Regards,

---

Dominick Gulli, District Engineer  
Reclamation District No. 1007

---



**Appendix J**  
**PL 84-99 Request Template**

**RECLAMATION DISTRICT NO. 1007**

**Pico Naglee Levee District**

**4600 S Tracy Blvd Suite 114**

**P.O. Box 1129**

**Tracy California 95378**

**(209) 835-3232**

**FAX (209) 835-7251**

**Trustees**

John Veirra

Betty Galli

Leonard Alegre

**Secretary and Attorney**

Robert Mehlhaff

**District Engineer**

Dominick Gulli PE,PLS

District Commander  
U.S. Army Engineer District, Sacramento  
1325 J Street  
Emergency Management Section  
Sacramento, CA 95814-2922

SUBJECT: PUBLIC LAW 84-99 ASSISTANCE REQUEST

Dear Sir:

The existing high water conditions constitute a flood threat to the safety of persons and property of Reclamation District No. 1007, Pico Naglee Tract, located in the County of San Joaquin, State of California.

The potential threat is beyond our capability to address. It is requested that the U.S. Army Corps of Engineers provide emergency assistance in the form of temporary protection.

Sincerely,

---

(signature) (public official)

---

(print name)

---

(title)

Contact phone: (209) XXX-XXXX  
(Contact Fax) : (209) XXX-XXXX

**Appendix K**  
**State of California Emergency Flood Fighting Methods**

STATE OF CALIFORNIA

EMERGENCY

# FLOOD FIGHTING

## Methods

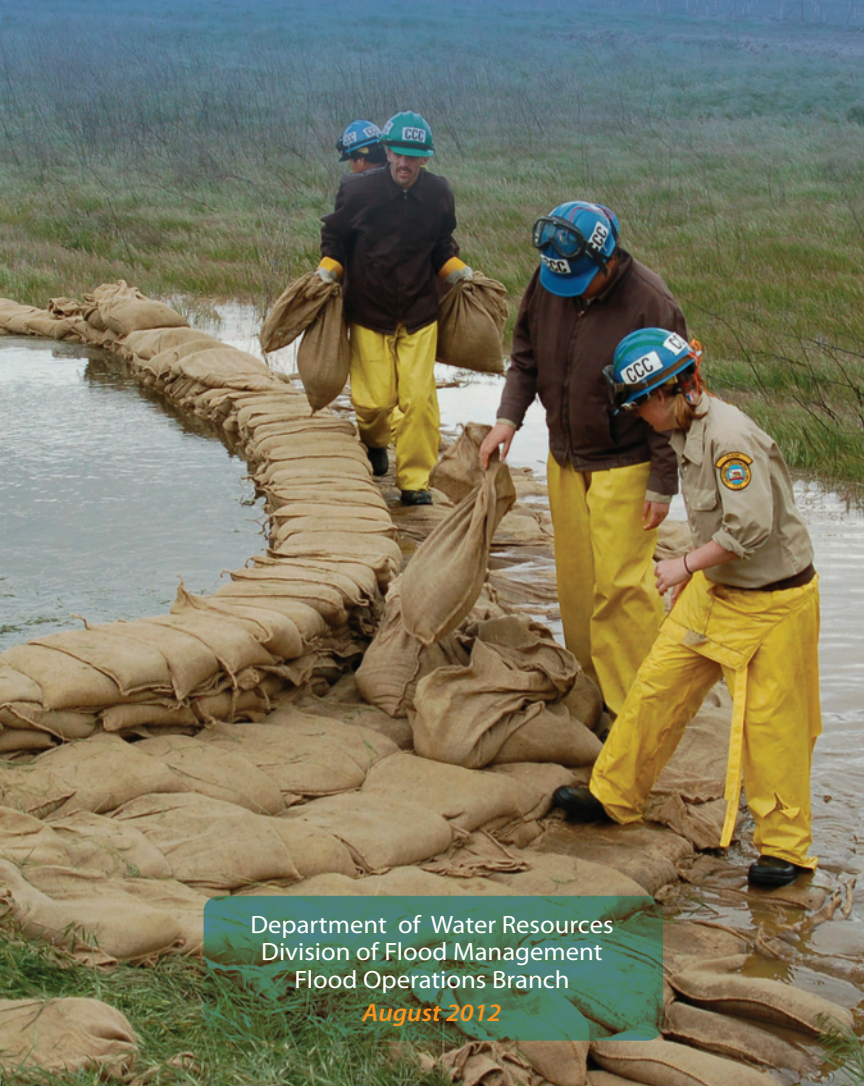

Department of Water Resources  
Division of Flood Management  
Flood Operations Branch

*August 2012*

STATE OF CALIFORNIA  
CALIFORNIA NATURAL RESOURCES AGENCY  
DEPARTMENT OF WATER RESOURCES

# **FLOOD FIGHTING**

## Methods



Division of Flood Management  
Flood Operations Branch

August 2012

*Prepared by*

**Rick Burnett**

Water Resources Engineering Associate

*with assistance from*

**Elizabeth Bryson**

Water Resources Engineer

**Xiao Li**

Graphic Designer



## Table of Contents

<b>2</b>	<b><i>Foreword</i></b>
<b>3</b>	<b><i>Levee and Embankment Threats</i></b>
<b>3</b>	<b><i>Patrolling</i></b>
<b>5</b>	<b><i>Filling Sandbags</i></b>
<b>7</b>	<b><i>Passing Sandbags</i></b>
<b>8</b>	<b><i>Sandbag Construction</i></b>
<b>9</b>	<b><i>Control of Overtopping (Sack Topping, Temporary Levee)</i></b>
<b>12</b>	<b><i>Control of Boils</i></b>
<b>16</b>	<b><i>Wavewash Protection</i></b>
<b>22</b>	<b><i>Raincoat Method</i></b>
<b>23</b>	<b><i>Emergency Spillway</i></b>
<b>24</b>	<b><i>Structure Protection / Diversions</i></b>
<b>28</b>	<b><i>Water / Storm Drain Protection</i></b>
<b>29</b>	<b><i>Flood Fight Safety</i></b>
<b>33</b>	<b><i>Flood Fighting Terminology</i></b>
<b>36</b>	<b><i>Reference Guide</i></b>
<b>37</b>	<b><i>Flood Fight Material/Equipment List</i></b>
<b>38</b>	<b><i>Levee Profile</i></b>

## **Foreword**

The California Department of Water Resources (DWR), Division of Flood Management has been tasked to prevent, reduce, and mitigate the risk of damages associated with flooding. For over fifty years DWR has been the lead State agency responsible for responding to this costly natural disaster. Our mission is to prevent loss of life and damage to property and infrastructure.

Working together State, federal, and local agencies manage California's Flood Control System which consists of reservoirs, levees, weirs, bypasses, and retention basins.

This statewide system is managed with support from technologies such as weather and water forecasting, coordination of reservoir releases and a network of rain and stream gauges and snow pack monitoring. The information gathered is extremely important to emergency responders and the public.

The 'Flood Fighting Methods' outlined in this booklet have proven effective during many years of use by DWR, United States Army Corps of Engineers, and local agencies on flood-related emergencies. This handbook is published by the DWR Flood Operations Branch and is designed to be used with the Flood Fighting Methods class.



## **Levee and Embankment Threats**

The main causes of levee failure or flood related problems due to high water are:

- Seepage through or under the levee heavy enough to cause a “boil”.
- Erosion of the levee or embankment due to swift moving water or wave action.
- Overtopping resulting from water-surface elevations higher than the levee or embankment.

## **Patrolling**

The best defense against flood related issues and/or levee failure is to identify problems early and repair them immediately. Biannual levee inspections and effective high water patrolling make this possible. The following suggestions will help in organizing patrol teams for this work.

- Operate under the SEMS / ICS system and report to the appropriate section chief.
- Provide a sufficient number of workers for two 12 hour shifts.
- Provide each worker with a copy of this ‘Flood Fighting Methods’ handbook.
- Assign two people to each mobile patrol.
- Assign each mobile patrol vehicle an area no larger than can be inspected at least every 2 hours, with more frequent patrols as conditions warrant. Foot patrols may offer a more thorough inspection.

- Furnish each mobile patrol vehicle with radio/cell phone or other communication equipment, lights for night patrol, and the following materials: Laths, survey ribbon, permanent marker, pad and pencil, flashlight with extra batteries, 2 shovels, 1 sledge hammer, approximately 50 sandbags (empty), 1 roll of plastic sheeting (visquine), 1 box twine, 100 buttons, 25 wooden stakes, lifeline, personal floatation devices, blanket, First Aid kit, Directory of Flood Officials, and Flood Emergency Phone Card. (see Reference Guide on page 36)
- Identify potential problems: boils, seepage, erosion, cracks, sloughing etc.
- Instruct each patrol team on the correct filling and placement of sandbags. They should know what danger signs to watch for, and how to signal for help.
- Vehicles should remain on high ground in threatened areas. Always have escape routes and make them known.
- Instruct each leader to check with their team members frequently. Investigate all reported problems.
- Be aware of the locations of stockpiled sandbags and other tools and equipment at strategic locations.
- Be prepared to obtain more workers, tools, and equipment on short notice.
- Advise the officials of the district or agency responsible for emergency assistance in the area and if necessary, request their help, i.e. local emergency services office.
- Contact the nearest representative of the Department of Water Resources for technical advice and assistance.

## **Filling Sandbags**

When filling sandbags you should work in pairs, with one person holding the bag while the other shovels in the fill material. The bag holder should find the most comfortable position while holding the bag open (see Figure 1 page 6). **The most common mistake made is overfilling bags.** The first shovel of fill should be placed on the lip of the bag to help hold the bag open. The shoveler should use rounded scoops of fill until the bag is approximately 1/3 full. While shoveling or holding, avoid extra movements (turning or twisting of the back) to prevent injury and reduce fatigue.



Filling Sandbags



Figure 1: Proper sandbag filling

## Passing Sandbags



Passing Sandbags

To avoid injuries and maximize productivity emergency responders can be organized into a sandbag passing line or 'chain'.

The line is formed by standing facing the next person and slightly off set. The bags are passed down the center of the chain.



Passing Sandbags

## **Sandbag Construction**

The use of sandbags is a simple but effective method of preventing or reducing damage from floodwater and debris. (see Figure 2) Suggestions for constructing sandbag structures are:

1. Close-weave burlap bags 18" x 30" are recommended for all sandbag construction when available.
2. Fold the empty top of the bag at a 45-degree angle to keep sand from leaching out.
3. Place each bag over the folded top of the preceding bag and stomp into place.
4. Stagger the second layer of bags over the seams of the preceding layer.
5. Stomp all bags to form a tight seal.
6. The last sandbag in a line is referred to as a Key Sack. The empty top of this bag is folded under and stomped into place.



Sandbag Wall Construction

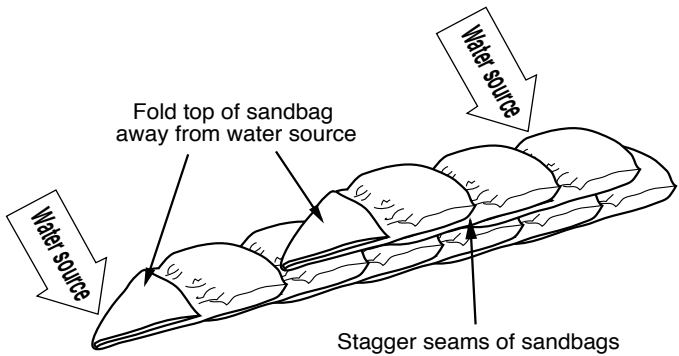

Figure 2: Fill sandbags 1/3 full, fold top of sandbag away from water source and stagger seams of sandbags.

## **Control of Overtopping**

If any levee reach or stream bank is lower than the anticipated high water elevation, an emergency topping should be constructed to raise the grade above the forecast flood height. A sack topping may be required at road or stock crossings, low levee sections, or railroad crossings. The following sections discuss various methods for increasing levee and bank elevations.

### ***Sack Topping***

The most common form of flood control work is the use of sandbags for construction of temporary walls. The use of sandbag walls to increase the height of a levee section is called “sack topping” (see Figure 3). The sacks are laid “as stretcher rows,” or along the levee.

Alternate layers can be crossed if additional strength is needed. The sacks should overlap at least one-third and stomped firmly into place. When properly placed and compacted, one sack layer will provide about 3 to 4 inches of topping.

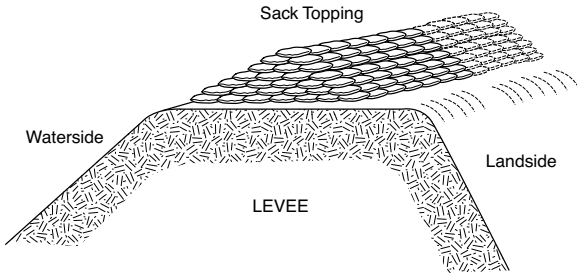

Figure 3: Sack topping on a levee



Sack Topping

### ***Temporary Levee***

This method is used to raise low areas during high water periods to prevent overtopping of levees, stream and riverbanks, small earthen dams, roadways, etc. To raise low areas, unfold a 20'x100'x10 mil roll of plastic sheeting and lay out flat on area to be raised (see Figure 4). Place fill material on plastic. Fold plastic over material, lay a single row of sandbags on the backside lip of plastic and on all seams. Fill material can be placed using bottom dump or dump bed trucks, front-end loader or manually.



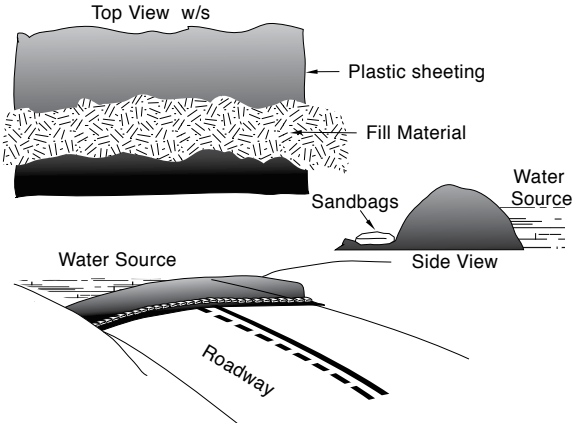

Figure 4: Temporary levee



Temporary Levee

**Lumber and Sack Topping**

Wooden panels are used on the waterside shoulder and reinforced on the opposite side with sandbags. The method is used to raise low reaches during high water and divert debris flows (see Figure 5). Stakes 2”x 4”x 6’ should be driven on the waterside shoulder 6 feet apart. A shallow trench is and lined with empty sandbags to provide a seal. Pre-constructed wooden panels are placed in the trench

and nailed to the landside of the stakes. This wall should then be backed with enough sandbags to support the panels against the expected high water. In some cases, it may be practical to back the panels with compacted earth in lieu of sandbags. Attach 2"x 4"x 10' lumber kickers to the stakes that support the panels, and drive 2' stakes into the levee crown. Use at least two nails at each joint to provide rigid construction.

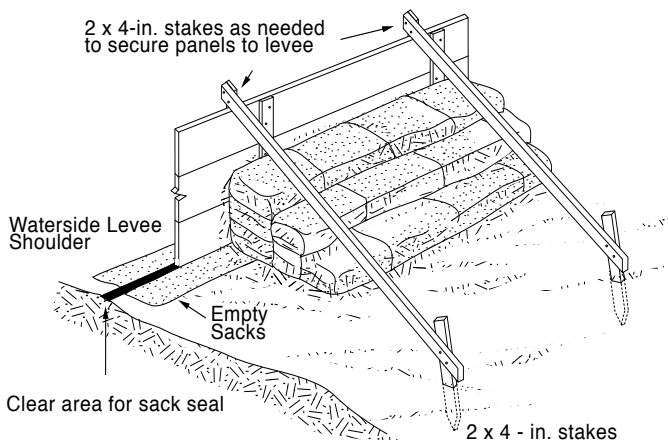

Figure 5: Lumber and sack topping

### **Control of Boils** (*Away from Levee*)

A boil is a condition that occurs when water is “piped” through or under a levee and resurfaces on the landside. These weak points are generally caused by burrowing rodents or decomposed tree roots. High water pressure can begin to erode the interior of the levee and weaken the structure. Levee material will deposit around the exit point as the water discharges on the landside. If the boil is determined to be “**carrying material**” then corrective action is required to control the situation.

If left unattended the material that makes up the levee can be eroded at an accelerated pace, causing subsidence and overtopping of the levee. This could result in a levee break.

The common method for controlling a boil is to create a watertight sack ring around it. The sandbag structure should be high enough to slow the velocity of the water and prevent further discharge of material from the boil (see Figures 6 & 7). The flow of water should never be stopped completely, since this may cause the boil to “break out” in an area near the existing sack ring. A spillway must be constructed to direct water away from all boil sites.

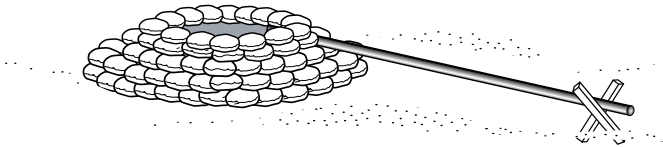

Figure 6: Boil sack ring

Bottom width should be at least  $1\frac{1}{2}$  times the height. Do not sack boils that are not carrying material, but continue to monitor. Boils can begin to carry material after first located.



Boil Sack Ring

The sack ring should be large enough to encompass the area immediately surrounding the discharge point (3 to 4 feet diameter). If several boils carrying material are found, a single large sack ring may be constructed around the entire “nest” of boils.

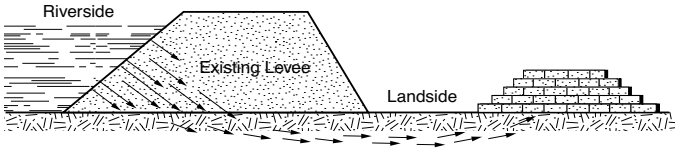

Figure 7: Flow of water through a levee

**Control of Boils (On Levee Slope)**

If the boil is close to or on the levee slope, a U-shaped sack ring may be built around the boil and keyed into the slope. Construction of this method can be difficult and requires substantial shoring up of the U-shaped sack ring structure. A spillway must be constructed to direct water away from all boil sites (see Figure 8).

*NEVER completely stop the flow from a boil. This may cause the boil to “break out” in an adjacent area. ALWAYS control the boil to a point where it ceases to carry material and the water runs clear.*



“U” shape Sack Ring

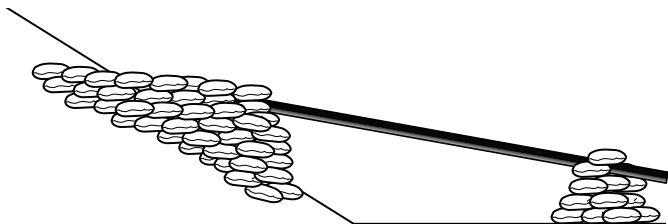

Figure 8: Spillways can be constructed by nailing two 2" x 6" boards together to form a V notch; PVC pipe; two parallel sandbag rows; visquine, etc.

### ***Waterside Boil Inlet Detection***

Water running through a levee and carrying material can sometimes be stopped on the waterside, thus eliminating the building of sack rings on the landside (see Figure 9). A six foot long section of 2" diameter metal pipe secured to a 5' x 6' foot piece of plastic or canvas can be rolled over the inlet hole on the waterside. Drive 1" x 3" x 2' stakes into the shoulder of the levee. Suspend half-filled sandbags on top of rolled-out material with twine and tie off to stakes. It can be difficult to locate the waterside inlet of boils. Sometimes a swirl is observed at the water's edge.

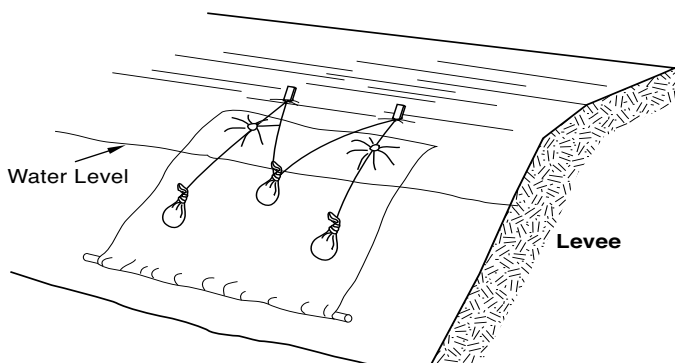

Figure 9: Waterside boil protection

## **Wavewash Protection**

All levees adjacent to wide stretches of water should be watched during periods of strong wind to detect the early stages of wavewash erosion. If the slope is well sodded, short periods of high wind should cause little damage. However during sustained periods of strong wind and high water, experienced personnel should observe and monitor the effected areas.

### ***Envelope Method***

When used correctly, plastic sheeting is useful for wavewash protection. Visquine should be purchased in 10 mil rolls, 20 feet wide by 100 feet long. 1"x3"x2' wooden stakes are driven into the ground just above the levee shoulder on the side you wish to protect. Place the stakes 4 feet apart and stagger vertically by 1 foot as shown in Figure 10.

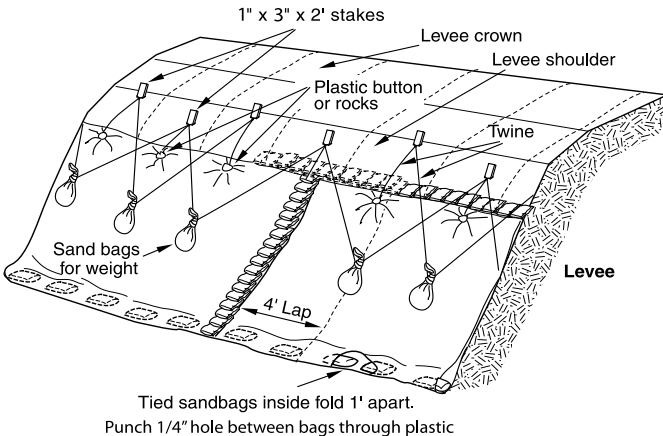

Figure 10: Wavewash Protection



Wavewash Protection

Avoid driving stakes in a straight line; this can cause cracking and sloughing of the slope. To provide added strength and leverage, drive stakes at a slight angle away from the water source with the wide (3") side facing the water. Be sure the stakes are well into the ground and are secure.

When rolling out the plastic sheeting it is helpful to use a shovel or similar long-handled tool. Eight to ten people should assist in shaking out the folds of the envelope. Be sure that both layers are held while the envelope is shaken out. Hold on tight! Use caution in strong winds. If the wind catches the plastic it could billow out and pull you along with it.

While flood workers hold the plastic securely, toss tied sandbags into the envelope. The tied sandbags (see Figure 12, page 20) are thrown into the bottom of the envelope with a one-foot gap between bags. The tied bags provide weight to hold the plastic against the levee slope.

A tie-down button or small stone (preferably round) is secured through both layers of visquine. If a stone is used, tie a slip knot and double half-hitch to secure it. Fasten buttons to the visquine and tie off to the stakes using a minimum 250 lb. tensile strength twine with these points in mind: (See Figure 11.)

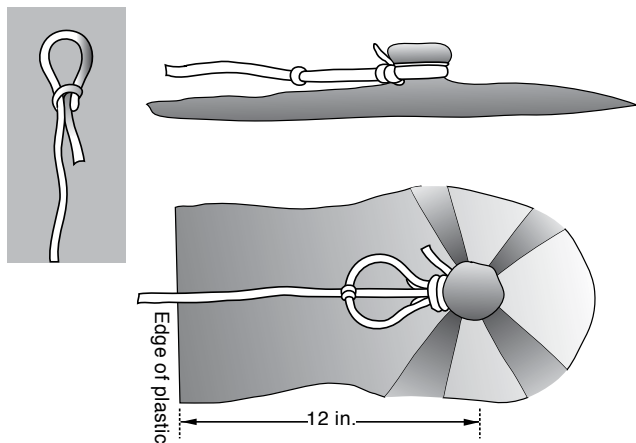

Figure 11: Plastic Tie-Down Buttons

1. Fasten button at least 1 foot from the edge of the plastic.
2. Fasten button to both layers of plastic.
3. Fasten button directly below stakes (one button per stake).
4. Tie twine low on stake for strength and to reduce tripping hazard.

Plastic sheeting is secured using tie down buttons. To attach plastic buttons to the plastic, tie a slipknot on the end of the twine; slip loop over button and plastic and draw tight. Tie two half-hitch knots around the throat of main body. Extend twine to large end of main body, tie a half-hitch knot around the end, and secure twine to stake (see Figure 11).

With the plastic secured to the stakes, punch a small hole between each tied bag in the envelope, (a pencil works well). These holes release water trapped in the envelope. **DO NOT** use a knife because a slice or slit will tear and





Button Tying

spread in the plastic. If further slope protection is necessary insert an additional envelope into the existing wavewash protection overlapping at least four feet. To secure the overlap to the stakes attach the two top layers with one button and the two bottom layers with another. The buttons line up with the stakes that are four feet apart. There should be four buttons securing the two envelopes.

Using a continuous piece of twine, hang tied bags from stakes in a zigzag fashion as shown in Figure 10. Tie a double half-hitch knot below the knot in each sandbag. ***Place each bag so that it hangs at the middle of the plastic directly below the stake between the two stakes from which it is suspended.*** Attach twine to every other stake with a double half-hitch. Add a second row of tied bags suspended from the stakes previously skipped. These bags will keep the plastic lying flat against the levee slope in windy conditions. If the upper portion of the slope needs protection, use an additional envelope. Be sure to place the upper layer over the lower layer by 2 to 3 feet. Finally place sandbags along all seams to prevent wind and water from entering the envelope. To prevent slippage, make sure the sandbags forming the top seam cap are half on the plastic and half on the

levee as shown in Figure 10. If the levee slope is too steep, some of the bags on the seam may be tied off with twine to the stake above the envelope for support.

Remember, wind is your worst enemy. When using plastic sheeting, be sure all seams are secured with sandbags, and make needed repairs to the envelope as soon as possible.

### ***Tying Sandbags***

Most sandbags are used with the open end folded. In some cases sandbags will have to be tied. Fill the bag  $1/4$  to  $1/3$  full of material. See Figures 12A–12D for instructions.

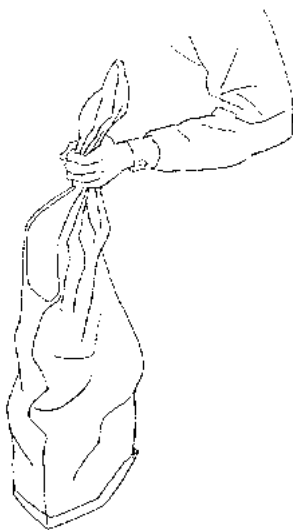

Figure 12A: Sandbag filled  
 $1/4$  to  $1/3$  full

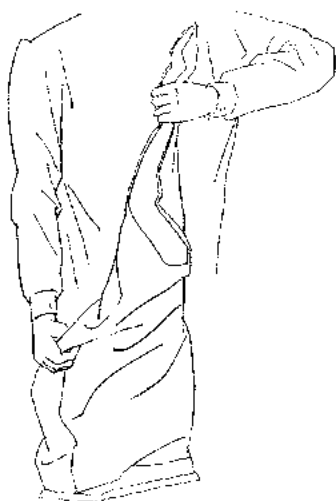

Figure 12B: Grasp bag at top  
corner and spin

Figure 12C: The long tail should be twisted tightly and look like a piece of rope.

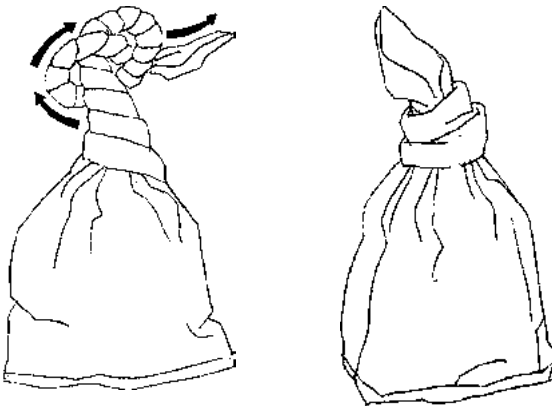
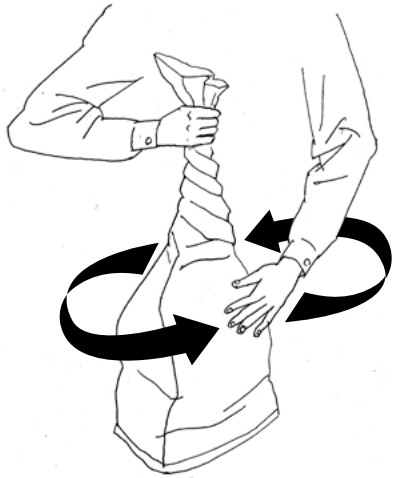

Figure 12D: Tie an overhand knot (pretzel knot) as low as possible on the bag.

### **Raincoat Method**

The raincoat method is used to prevent further saturation of levee or hillside slopes. Plastic sheeting is laid out flat on the slope, sandbags are placed around the perimeter with additional bags placed randomly for weight.



Plastic sheeting is laid out flat on the slope, sandbags are placed around the perimeter with additional bags placed randomly for weight. If the slope is steep, wooden stakes can be driven into the ground just above the area to be protected. The stakes are 4 feet apart with a 1-foot stagger. The plastic is secured to the stakes with tie-down buttons or small round rocks (see Figure 13).

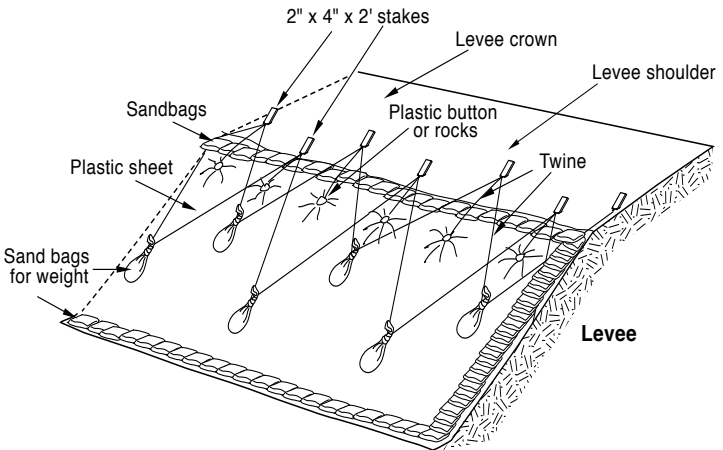

Figure 13: Raincoat method

Use a crisscross method of placing the sandbags (Figure 13) on the plastic. Place a solid row of sandbags on all edges of the plastic (half on the ground, half on the plastic).

## **Emergency Spillway**

To prevent damage to the levee slope due to overtopping, an emergency spillway can be constructed.

Place plastic sheeting over area to be used for spillway. Line all sides with at least a single row of sandbags. Use additional tied sandbags on plastic for weight if needed.

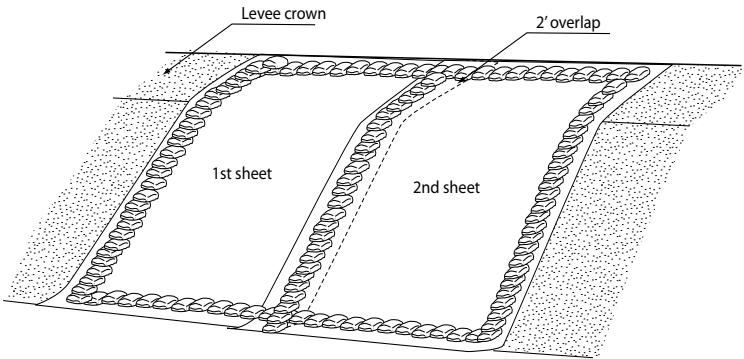

Figure 14: Emergency spillway using plastic sheeting and sandbags



Emergency Spillway

## **Structure Protection/Diversions**

The main causes of damage to structures, homes, and property during heavy rains or flood flows are:

1. Flood water from overwhelmed storm drains and urban diversions, particularly on sloping streets.
2. Flood flows onto property through driveway openings and low spots in curbs.
3. Debris flow from hillsides that have been cleared of vegetation by fire or real estate development.

The flood fighting methods described in the following sections have proved effective in combating floodwaters and debris flows.

### ***Diverting Water or Debris Flows Away from Structures***

Homes and structures can be protected from floodwater or debris flows by redirecting the flow as shown in Figure 15. Sandbag barriers must be long enough to divert the flows away from all structures. Barriers constructed of sandbags or lumber can also be used to channel mud and debris away from property improvements.



Structure Protection



Structure Protection

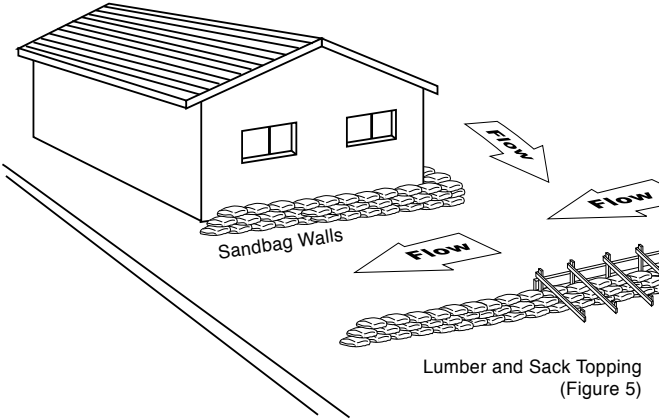

Figure 15: To divert mud, debris, and water, use sandbag walls or lumber and sack topping

### **Structure Protection**

The following method is used for protection of buildings and other structures along lake shores and in similar situations where water is rising with little or no current.

Lay plastic sheeting on the ground and up the building walls to a point at least 1 foot above the predicted water elevation, and far enough out on the ground to form a half pyramid of sandbags (see Figure 16). Secure plywood over doors and vents. Overlap plastic sheeting and sandbags at corners of buildings.



Home Protection

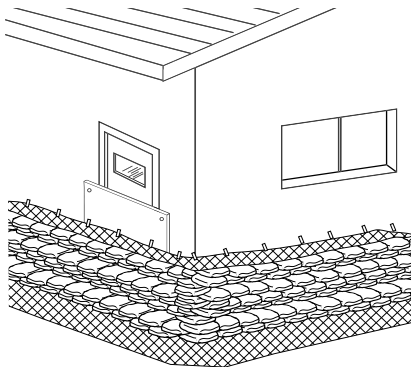

Figure 16: Structure protection



## ***Wet Flood Proofing Requirements for Structures Located Within Special Flood Hazard Areas***

National Flood Insurance Program regulations require that buildings on extended wall foundations or that have enclosures below the base flood elevation must have foundation or enclosure wall openings. These openings prevent the foundation or enclosure walls from weakening or collapsing under pressure from hydrostatic forces during a 100 year flood event. The openings allow flood waters to reach equal levels on both sides of the foundation or enclosure wall and minimize the potential for damage from hydrostatic pressure.

**THESE OPENINGS MUST NOT BE BLOCKED IF THE BUILDING IS LOCATED WITHIN A SPECIAL FLOOD HAZARD AREA.**

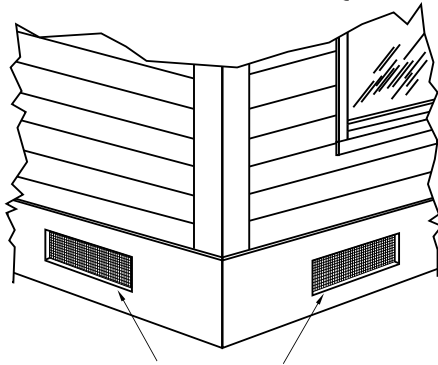

**Foundation or wall openings must be kept open within special flood hazard areas**

Figure 17: Foundation and wall openings in structures

For details refer to FEMA Technical Bulletins TB1-93 and TB-7.

These bulletins may be obtained from the FEMA web site at:

*<http://www.fema.gov>*

For additional information contact DWR Floodplain Management at

(916) 574-1475

## **Water / Storm Drain Protection**

Water or sewer systems can be protected by placing corrugated metal pipe (CMP) over the utility hole (see Figure 18). Lay plastic sheeting up the walls of the CMP and place sandbags in the form of a half pyramid around the CMP to seal it to the pavement. This method will prevent mud and debris from entering the system and also act as a surge chamber.

### **CITY WATER PROTECTION**

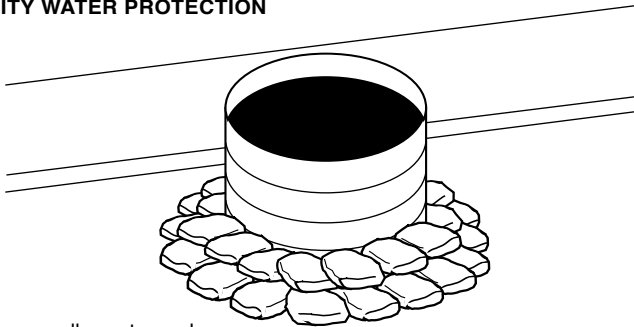

Use sandbags to seal pipe to pavement.

Using corrugated metal pipe (CMP) over utility hole to isolate sewer line or prevent contamination of water system.

Figure 18: Water / storm drain protection

## **Flood Fight Safety**

Numerous potential hazards exist during flood events. These hazards are manageable if identification and communication occur on an ongoing basis. Personal safety requires a conscious effort that every flood fighter must consider in their various duties and activities.

- ***Changing Weather Patterns:*** This occurrence can affect existing conditions and create more serious situations. Always know the forecast and how it affects vulnerable areas, workers and the public.
- ***Changing Water Patterns:*** The rise and fall of water can occur gradually or very quickly. Knowledge of high water and how it relates to levees, communities, and workers is essential. Continuous monitoring and communication of water level influences (i.e. reservoir releases, tides, and drainage inflow) are very important. Always know your area and the flood history around you.
- ***Swift Water:*** High velocities of water are common during flooding events. Extreme caution should be used when anyone is exposed to high water. Workers should have flotation devices, throw ropes, and lifelines in the immediate area. Swift water rescue teams may be available. Use common sense and sound judgement around swift water. Know your resources and how to activate them prior to the event.
- ***Temperature Related Illness:*** During a flood fight, weather patterns can change constantly. Changes in temperature present the potential for hypothermia and heat exhaustion/stroke. Flood fighters should know the signs of distress for these types of illnesses and how to treat them. During cold, wet weather it is recommended that workers layer clothing to stay warm and dry. A dry

blanket and warm clear fluids should be on the work site for emergency use. In warm, hot weather lightweight clothing is recommended. If skin is exposed, a sun block agent may need to be applied. Plenty of drinking water should be on site and consumed regularly. Headgear is recommended in both hot and cold situations.

- ***Insect/Animal Exposure:*** Flooded areas force a variety of animals to evacuate to high ground. Workers in these areas should be aware of these animals and not handle them. If animal removal is needed, contact a local professional. Stinging and biting insects are prominent in certain flood-prone areas. Chemical repellents can be useful as a deterrent. A complete first aid kit should be on site.
- ***Vegetation:*** Noxious plants such as star thistle, stinging nettle, and poison oak are commonly found along rivers, streams, and levees. Avoid direct contact with this type of vegetation to prevent itching and rash. Consult medical personnel if symptoms persist.
- ***Sandpile Safety:*** When shovels are used for filling bags a safe distance for workers is essential. Sandbags and sand may contain contaminants. Have disinfectant available. Safety glasses or goggles are recommended for protection from blowing sand particles.
- ***Contamination:*** Flooded areas can potentially carry high levels of contaminants. Common contaminants include fuel, sewage, and pesticides. Local Haz-Mat teams should be contacted if needed. Always wear protective clothing to help limit contact with water. Carry antibiotic hand soap and wash thoroughly after working around floodwater.
- ***Exhaustion:*** Stress combined with long, physically demanding hours can have an adverse effect on the flood

worker. It is very important to recognize exhaustion or sleep deprivation and treat them immediately. Operation of vehicles, machinery, or equipment should be avoided. A shift rotation of personnel will help eliminate fatigue factors.

- **Body Mechanics:** Proper body mechanics while working on floods is very important. The body is expected to work long, physical hours during the event. Each individual must make a conscious effort to use safe lifting and weight distribution techniques. Watch your footing; surfaces can be slippery and cluttered with tripping hazards.
- **Construction Equipment:** There are times when equipment and people will occupy the same work area. Workers should wear safety vests and hard hats and be aware of their surroundings. Safety warning devices (i.e. backup alarms and lights) should be in-tact and working on all equipment. Communication and alertness are vital! All operators must be certified for their equipment.
- **Boat Travel:** Materials and/or personnel will sometimes need to be transported to work sites by boat. Operators of the watercraft must be certified. Flotation devices must be available for every passenger. Extreme care should be taken while loading and off loading.
- **Patrolling:** Patrolling is the key to effective flood fighting. Patrols will identify, initiate control, and monitor trouble spots in affected areas. Vehicle patrols should travel in two person teams with dependable communication devices. Lifelines, flotation devices, and a blanket should be in the vehicle for possible water-related accidents. Foot patrols should also have the same considerations. Extreme caution should be exercised when travelling saturated, cracking, or sloughing areas.

- **Vehicle Placement:** Vehicles in work areas along the levee should remain parked on high ground. This is usually the crown roadway. Vehicles should also be parked facing their access point. An escape plan should be communicated to all flood workers.
- **Structure Considerations:** When working around structures, be aware of downed power lines, natural gas or propane leaks, and unstable structure supports. Communicate with the structure owner if possible.
- **Safety Gear:** Rain gear, warm clothing, handheld lights, gloves, goggles, hardhat, boots, first aid kit, ropes, personal flotation devices (PFD), hip waders.



## **Flood Fighting Terminology**

<b>Boil</b>	Also known as 'Sand Boil', is caused by water flowing through or under a levee, possibly carrying eroded levee material, and surfacing on the land side of the levee.
<b>Button</b>	A plastic tie down device used with plastic sheeting.
<b>Emergency Spillway</b>	Plastic sheeting and sandbags used to allow water to flow over a levee, protecting it from erosion. (Page 23)
<b>Flood Fighting</b>	An effort made to prevent or mitigate the effects of flood waters.
<b>Home Protection</b>	Plastic sheeting and sandbags placed around individual homes to protect from low current flood waters. (Page 26)
<b>Lath</b>	Long, narrow wooden stakes (4 feet long by 1 ½ inch wide) used to mark problem areas during high water patrolling. A brief description of the problem along with the date, time, and patroller's initials are written on the lath with a permanent ink marker. Brightly colored survey ribbon is attached to the lath for easy identification.
<b>Levee</b>	An earthen structure that parallels a river or stream designed to prevent high water flows from inundating urban and/or agricultural land.

<b>Levee Break</b>	A point in the levee system that has failed to perform its designed function, has eroded away and is allowing water to inundate land.
<b>Levee Breach</b>	The same as Levee Break but can sometimes describe a section of levee that has been intentionally broken. If intentional, also known as a relief cut.
<b>Lumber and Sack Topping</b>	Wooden panels and sandbags used to prevent overtopping and to divert water, mud, and debris flows. (Page 11)
<b>Overtopping</b>	When water has risen higher than the banks of a waterway or the top of a levee.
<b>Plastic Sheeting</b>	Made of polyethylene, these 100'x20'x10 mil rolls are sometimes referred to as visquine and are used for erosion control.
<b>Rain Coat</b>	A single layer of plastic sheeting and sandbags used to protect slopes from further rain saturation. (Page 22)
<b>Relief Cut</b>	Intentionally-removed section of levee to relieve hydrologic pressure upstream and downstream of the levee section.
<b>Sack Ring</b>	Multiple sandbag rings used to encircle a boil, slow the flow of water, and stop the erosion of levee material. (Page 13)
<b>Sack Topping</b>	A sandbag wall designed to prevent overtopping. (Page 9)



<b>Sandbag</b>	An 18"x30" bag (burlap or plastic) filled with sand or other appropriate material intended for use as a temporary flood fighting measure.
<b>Sloughing</b>	Soil movement or slides often caused by over-saturated levee or hillside slopes. Can also be referred to as 'mud slides'.
<b>Structure Protection</b>	Sandbags, wooden panels, or other materials used to divert water, mud, and debris flows away from buildings, homes, and other structures. (Page 24)
<b>Temporary Levee</b>	Use of plastic sheeting, fill material and sandbags to raise a low area on a levee or embankment. (Page 10)
<b>Twine</b>	250lb tensile strength polypropylene tying twine.
<b>'U' Shaped Sack Ring</b>	A sandbag structure used on levee slopes to control boils. (Page 14)
<b>Wooden Panels</b>	Wooden planks or plywood sheets used in conjunction with other flood fighting materials to prevent overtopping of levees or embankments and divert water.
<b>Wavewash</b>	Wind-generated waves breaking against a levee or embankment and possibly causing erosion.
<b>Wavewash Protection</b>	Plastic sheeting, sandbags, twine, stakes, and buttons used to prevent erosion of levee slopes and embankments. (Page 16)

## Reference Guide:

DWR Division of Flood Management  
**[www.water.ca.gov/floodmgmt](http://www.water.ca.gov/floodmgmt)**

California Data Exchange Center  
CDEC  
**[www.cdec.water.ca.gov](http://www.cdec.water.ca.gov)**

California Emergency Management Agency  
CalEMA  
**[www.calema.ca.gov](http://www.calema.ca.gov)**

National Weather Service  
**[www.weather.gov](http://www.weather.gov)**

To request a copy of the Directory of Flood Officials or Flood Emergency Phone Card, contact the DWR Flood Operations Center at (916) 574-2619



## **Flood Fight Material/Equipment List**

Fill/Repair material (Sand, Rock, Road Base)  
 Sandbags (18" width x 30" length 10 oz.)  
 Plastic Sheeting (100'x20'x10 millimeter rolls)  
 Wooden Stakes (1"x3"x24")  
 Bailing Twine (250lb tensile strength)  
 Tie Down Buttons  
 Geotextile Fabric (20'x100' rolls)

### ***Patrolling***

Patrol Vehicle (4Wheel Drive)  
 Communication Devices (Radio, Cell Phone, Laptop Computer (e-mail)  
 Global Positioning Satellite Handheld Device (GPS)  
 Digital Camera  
 Lighting (Flash Light, Flood Light)  
 Batteries  
 Lath (Bundle of 50)  
 Survey Ribbon (Bright Colors)  
 Permanent Ink Markers  
 Patrol Log (Writing Pad and Pencil)  
 Measuring Tape (100')

### ***Tools***

Shovels, Long Handle (#2 Mud Shovel)  
 Sledge Hammer (10lb)  
 Multi Purpose Lineman Pliers  
 Pulaski  
 McLeod  
 Loppers

### ***Safety***

Rain Gear  
 Rubber Boots  
 Hard Hat  
 Safety Glasses  
 Gloves  
 Boots  
 Personal Flotation Device (PFD)  
 Personal Safety Light  
 Warm Clothing  
 First Aid Kit

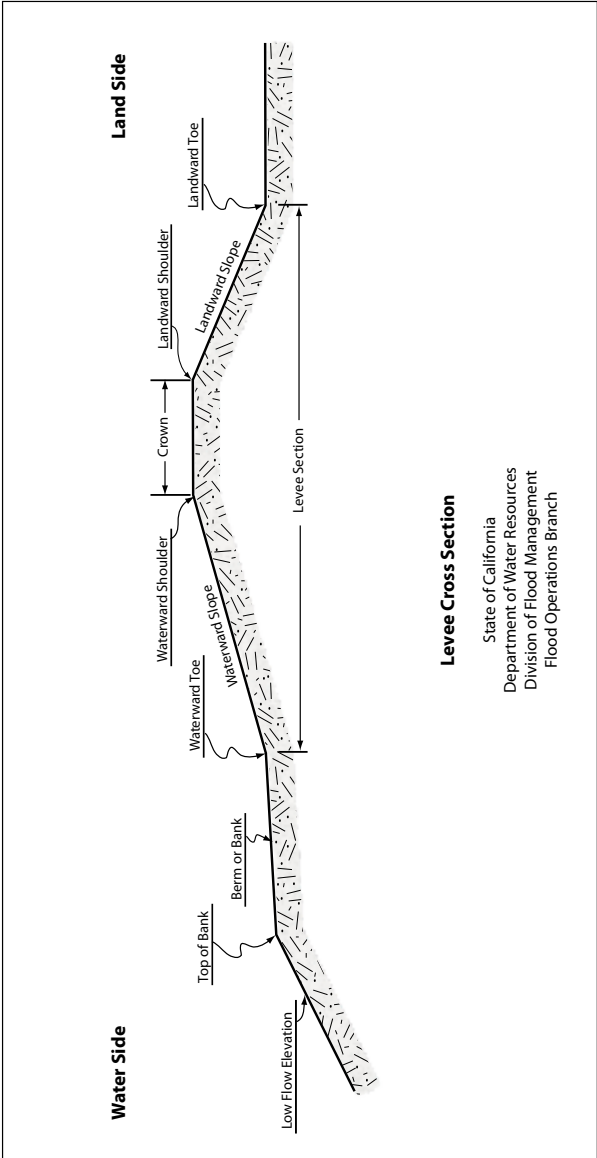



*For all flood training information, emergencies, questions, or for additional information, please contact :*

**State-Federal Flood Operations Center**  
**(916) 574-2619**  
**[flood\\_center@water.ca.gov](mailto:flood_center@water.ca.gov)**

*For training information, contact:*

**Rick Burnett**  
*Flood Fight Specialist*  
**(916) 574-1203**  
**[rburnett@water.ca.gov](mailto:rburnett@water.ca.gov)**  
**[www.floodfightmethods.org](http://www.floodfightmethods.org)**



## **Appendix L**

### **Office of Emergency Services After-Action-Report**



**PART II SEMS FUNCTIONS EVALUATED**

SEMS FUNCTIONS	TOTAL PARTICIPANTS (Each Function)	EVALUATION		CORRECTIVE ACTION REQUIREMENTS:				
		Circle: (S) or (NI) (Satisfactory) (Needs Improvement)		(Check to indicate corrective actions required) PLANNING   TRAINING   PERSONNEL   EQUIPMENT   FACILITIES				
<b>Management:</b> Public Information Safety, Liaison, Inter-agency Coordination, Security, etc.		S	NI					
<b>Command (Field)</b> Public Information Safety, Liaison, Inter-agency Coordination, Security, etc.		S	NI					
<b>Operations:</b> Law Enforcement, Fire/ Rescue, Const. & Eng., Medical/ Health, Care & Shelter etc.		S	NI					
<b>Planning/ Intelligence:</b> Situation Status & Analysis, Documentation, Advance Planning, Demobilization etc.		S	NI					
<b>Logistics:</b> Services, Support, Facilities, Personnel, Procurement, Supplies, Equipment, Food etc.		S	NI					
<b>Finance Administration:</b> Purchasing, Cost Unit, Time Unit, Compensation and Claims etc.		S	NI					
<b>Other Participants:</b> Exercise Staff, Community Volunteers, etc.								
<b>Grand Total:</b>								



### PART III - AFTER ACTION REPORT QUESTIONNAIRE

Complete this questionnaire for all functional or full-scale exercises, and actual INCIDENTS. Responses to questions 18-26 should address areas identified as “needing improvement and corrective action” in Part I, as well as any “No” answers given to questions 1-17 below:

<u>INCIDENT NAME:</u>	<u>PLANNED EVENT / EXERCISE NAME:</u>		
QUESTION:	YES	NO	N/A
1. Were procedures established and in place for response to the incident?			
2. Did your jurisdiction organize the response using established procedures?			
3. Did field command use ICS to manage field response?			
4. Did field command use all ICS Sections?			
5. Did field command establish a Unified Command?			
6. Was your EOC and/or DOC activated?			
7. Was the EOC and/or DOC organized according to SEMS?			
8. Did your jurisdiction assign sub-functions in the EOC / DOC around the five SEMS functions?			
9. Did your jurisdiction use trained response personnel in the EOC / DOC?			
10. Did your jurisdiction use action plans in the EOC / DOC?			
11. Did field level personnel use action-planning processes?			
12. Did your jurisdiction coordinate with volunteer agencies?			
13. Did your jurisdiction request and receive Mutual Aid?			
14. Was Mutual Aid coordinated from the EOC / DOC			
15. Did your jurisdiction establish an inter-agency coordination group established at the EOC / DOC level?			
16. Did your jurisdiction conduct public alert and warning according to procedures?			
17. Did your jurisdiction coordinate public safety and incident information media?			
18. During your response, was there any part of SEMS that did not work for your agency? If so, how would (did) you change the system to meet your needs?			
19. As a result of your response, are any changes needed in your plans or procedures? Please provide a brief explanation:			
20. Identify any specific areas not covered in the current SEMS Approved Course of Instruction or SEMS Guidelines.			
21. Did your jurisdiction identify any issues for people with access and functional needs during sheltering, evacuation, alert and warning or access to assistance centers? If so, provide a brief explanation.			
22. Did your jurisdiction identify any issues during coordination with any Emergency Function (EF)? If so, provide a brief explanation including the EF number and the issue.			
23. Did your jurisdiction use volunteers during this incident or event? If so, please elaborate on the activities performed and any organizational affiliation if any.			

<p>24. Did your jurisdiction establish shelters during this incident of event? If so, how many shelters?</p>
<p>25. Did your jurisdiction identify any issues during this incident of event regarding pets or livestock? Please elaborate what the issues were and what actions your jurisdiction took to resolve the issues.</p>
<p>26. Did your jurisdiction establish an assistance center?</p>

**PART IV - NARRATIVE**

Use the space below to provide additional comments pertaining to Part III questions 18-26, or for any additional observations:

**FORM COMPLETED BY:**

\_\_\_\_\_(  
**Print Name)**

**BUSINESS PHONE:**

**YOUR AGENCY NAME:**

**REPORT DUE DATE:**

\_\_\_\_/\_\_\_\_/\_\_\_\_  
**DATE COMPLETED:**

\_\_\_\_/\_\_\_\_/\_\_\_\_

**OES USE ONLY**

**DATE RECEIVED:**  
\_\_\_\_/\_\_\_\_/\_\_\_\_

**RECEIVED BY:**  
\_\_\_\_\_

**PART V- RESPONSE SUMMARY**

**State and local agencies response activities chart**

The following chart summarizes the wide array of activities that local and state agencies/departments performed during the *(Name of Incident)*. It reflects the various mutual aid systems (fire and rescue, law enforcement, medical), as well as other state response capabilities.

Note: Agencies and organizations not required to provide specific information on personnel and equipment deployment. However, if available, include the information in the matrix. N/A= data not available, not submitted.

<b>Agency/Dept.</b>	<b>Period of Commitment</b>	<b>Personnel</b>	<b>Equipment</b>
<i>Name of State or Local Agency</i>			
<b>Activities:</b>			

<b>Agency/Dept.</b>	<b>Period of Commitment</b>	<b>Personnel</b>	<b>Equipment</b>
<i>Name of State or Local Agency</i>			
<b>Activities:</b>			

<b>Agency/Dept.</b>	<b>Period of Commitment</b>	<b>Personnel</b>	<b>Equipment</b>
<i>Name of State or Local Agency</i>			
<b>Activities:</b>			

**PART VI - RECOVERY SUMMARY**

**State and local  
agencies recovery  
activities chart**

<b>Agency/Dept.</b>	<b>Period of Commitment</b>	<b>Personnel</b>	<b>Equipment</b>
<i>Name of State or Local Agency</i>			
<b>Activities:</b>			

<b>Agency/Dept.</b>	<b>Period of Commitment</b>	<b>Personnel</b>	<b>Equipment</b>
<i>Name of State or Local Agency</i>			
<b>Activities:</b>			

<b>Agency/Dept.</b>	<b>Period of Commitment</b>	<b>Personnel</b>	<b>Equipment</b>
<i>Name of State or Local Agency</i>			
<b>Activities:</b>			

Standardized Emergency Management System

AFTER-ACTION REPORT INSTRUCTION SHEET

**REASONS FOR COMPLETING THIS FORM:**

*[Note: Pursuant to §2450(a), Chapter 1, Division 2, Title 19 CCR, “any city, city and county declaring a local emergency for which the governor proclaims a state of emergency, and any state agency responding to that emergency, shall complete and transmit an after-action report to OES within ninety (90) days of the close of the emergency period as specified in CCR, Title 19, §2900(j).”]*

Beyond the statutory requirement for after-action reports, information collected through this process is important for the California Governor’s Office of Emergency Services in ensuring the effectiveness of the Standardized Emergency Management System. Information can also demonstrate grant performance activity associated with FEMA training and exercise programs; thus providing justification for future grant funded emergency management programs for California.

Affiliated agencies such as contract ambulance companies, volunteer agencies to include the American Red Cross and Salvation Army, and any other agency providing a response service during an actual occurrence or functional or full-scale exercise should complete this form.

**PART I – GENERAL INFORMATION:**

Please fill this information out completely. Check all boxes that apply. The following information provides additional clarification:

- **TYPE OF AGENCY:** If “other,” indicate volunteer, contract, private business, etc.
- **DATES OF EVENT:** Beginning date is the date your agency first became involved in the response to the event or exercise. Ending date is the date the response phase or exercise officially ended.
- **TYPE OF EVENT:** Planned events are parades, demonstrations, or similar occurrences.

**PART II – SEMS FUNCTIONS EVALUATED:**

- **SEMS FUNCTION:** Descriptors under the principal SEMS functions (Management, Command, Operations, Planning/Intelligence, Logistics, and Finance Administration) are examples only. We recognize that terminology describing the elements of an “Operations Function” may vary according to the type of agency. Provide clarification in Parts III and IV, if necessary.
- **TOTAL PARTICIPANTS:** All participants in each principal SEMS function. It is not necessary to itemize the number participating in each element under the principle function.

## **PART II – SEMS FUNCTIONS EVALUATED:**

- **EVALUATION:** If all elements of principal SEMS function were generally satisfactory, circle (S). If you noted deficiencies, circle (NI).
- **CORRECTIVE ACTION:** If you circled (NI) under EVALUATION, indicate whether the corrective action pertains to “planning, training, personnel...” etc. Further clarification should be provided in Part II, Questions 18-26, and Part III Narrative as desired.
- **OTHER PARTICIPANTS:** This box generally applies to exercises. Please indicate the total number of exercise staff, i.e.: controllers, simulators etc., and any community volunteers (simulated victims, moulage, etc.), in the parenthesis. Add this number to the Grand Total box.

## **PART III – AFTER ACTION REPORT QUESTIONNAIRE:**

- **QUESTIONS 1-17:** Answer “YES, NO, or N/A (Not applicable)”.
- **QUESTIONS 18-26:** Responses to these questions should address areas identified as “N/I” or requiring “Corrective Action,” in Part I; as well as any “NO” answers given to questions 1-19.

## **PART IV – NARRATIVE:**

This is optional space provided for further clarification and information relating to Parts II & III.

- **FORM COMPLETED BY:** Please print your name legibly in the space provided.
- **REPORT DUE DATES:** Please indicate the due date (Ninety days from the end of the response phase, or completion of the exercise).
- **DATE COMPLETED:** The actual date the report is completed and sent to OES.

## **PART V – RESPONSE SUMMARY:**

This is an optional space for field level response activities if the information is available.

## **PART VI – RECOVERY SUMMARY:**

This is an optional space for field level recovery activities if the information is available.

*Please forward completed reports to Cal OES at [SharedMail.CalAAR@CalOES.ca.gov](mailto:SharedMail.CalAAR@CalOES.ca.gov). If you have questions or need further assistance, please contact Scott Marotte at call (916) 845-8780. Agencies are encouraged to maintain copies of this report on file for recordkeeping purposes.*

**Appendix M**  
**Engineer's Levee Threat Assessment Document**





**State of California  
Natural Resources Agency  
Department of Water Resources  
DIVISION OF FLOOD MANAGEMENT**

# Engineer's Levee Threat Assessment



October 2012

**John S. Laird**

Secretary for Resources

California Natural Resources Agency

**Edmund G. Brown, Jr.**

Governor

State of California

**Mark W. Cowin**

Director

Department of Water Resources

**For Official Use Only**

REVISIONS			
REV	DESCRIPTION	DATE	APPROVED



**DRAFT**

**This page is intentionally left blank.**

REVISIONS			
REV	DESCRIPTION	DATE	APPROVED



**If this levee threat is predicted to cause catastrophic failure within forty-eight (48) hours, DO NOT fill out this assessment. Contact the State-Federal Flood Operations Center at (916) 574-2619.**

*Purpose:*

The purpose of the Engineer's Levee Threat Assessment (ELTA) is for local maintaining agencies' engineers to identify and collect information about levee conditions and specific threats. This may include defects that have occurred due to high water, weather, debris, damage, vandalism, etc. In order to ensure consistency and completeness of documentation for levee threats, the ELTA standardizes the information collected, defines key decision criteria, and streamlines the process of assessing the severity of the threat and urgency of the repair or response. This assessment provides a vehicle for local maintaining agencies (LMA) to disclose specific threat conditions to DWR and open a discussion about concerns and possible mitigation actions. The ELTA does not discriminate against project and non-project levees. The ELTA takes into account only a "snapshot in time" using the date at which the assessment physically took place. Revisions may need to be resubmitted based on changing conditions. Not all of the information requested on the ELTA is required, but adequate information should be provided to justify further actions. Attachments such as maps, pictures, and previous reports are highly encouraged.

The ELTA shall be completed and stamped by a California licensed Profession Engineer (P.E.) or Certified Engineering Geologist (C.E.G.). The FOC will then use information collected during the initial DWR site visit and the information contained in the ELTA to determine whether or not the threat meets the criteria for imminent threat. If the levee threat is determined not to be an imminent threat, the LMA should pursue a permanent repair and secure funding through assessments, grants, and other programs administered by the Department of Water Resources (DWR) and the U.S. Army Corps of Engineers (USACE). The FOC is not the lead for any programmatic repairs.

The goal of the State-Federal Flood Operations Center (FOC) is to mitigate levee threats so that programs outside of emergency response can properly investigate, design, permit, contract, and construct permanent repairs. If this levee threat is predicted to cause catastrophic failure within five (5) days, it may be considered for an imminent threat response.

*Contact Information:*

**Bill Croyle, P.E.**  
Chief, Flood Operations Branch  
Phone: (916) 574-2611  
Email: [wcroyle@water.ca.gov](mailto:wcroyle@water.ca.gov)

**Sean de Guzman**  
Water Resources Engineer  
Phone: (916) 574-0640  
Email: [sdeguzma@water.ca.gov](mailto:sdeguzma@water.ca.gov)

**Todd Bernardy, P.E.**  
Chief, State-Federal Flood Operations Center  
Phone: (916) 574-1358  
Email: [tbernard@water.ca.gov](mailto:tbernard@water.ca.gov)

**State-Federal Flood Operations Center**  
Phone: (916) 574-2619 (24-hour)  
Email: [flood\\_center@water.ca.gov](mailto:flood_center@water.ca.gov)

*Disclaimer:*

This ELTA and any attachments may contain confidential information for the sole use of the intended recipient(s). Any unauthorized use, disclosure, viewing, copying, alteration, dissemination or distribution of, or reliance on this assessment is strictly prohibited. The FOC does not conduct long-term repairs nor declare emergencies, but merely mitigates levee threats.

REVISIONS			
REV	DESCRIPTION	DATE	APPROVED



Initial Observation Date:		Response Date:	
Time:		Time:	

Local Contact:		Phone & Type:	
<input type="checkbox"/> Project Levee	<input type="checkbox"/> Non-Project Levee	Alt Phone & Type:	

ATTENDEES AT LEVEE ASSESSMENT				
Name	Title	Company	Phone	Email

CONTACTS	
Name	Phone
DWR:	
Maintaining Agency:	
Maintaining Agency Engineer:	
Other:	

LOCATION OF DISTRESS	
Location:	Watercourse:
County:	Maintaining Agency:
Latitude:	Levee Unit Number:
Longitude:	Levee Mile/River Mile/Station:
Datum:	Right/Left Bank:
Position:	<input type="checkbox"/> Waterside <input type="checkbox"/> Landside <input type="checkbox"/> Crown <input type="checkbox"/> Slope
Location Description:	

TYPE OF DISTRESS							
<input type="checkbox"/> Cracking	Length:		Width:		Depth:		Direction:
<input type="checkbox"/> Sloughing	Length:		Width:		Depth:		Direction:
<input type="checkbox"/> Erosion	Length:		Scarp Height:		Berm Width:		Crown Width:
<input type="checkbox"/> Seepage	Length:		Flow Rate:		Material Transport:	<input type="checkbox"/> Yes <input type="checkbox"/> No	
<input type="checkbox"/> Boil	Diameter:		Flow Rate:		Material Transport:	<input type="checkbox"/> Yes <input type="checkbox"/> No	
<input type="checkbox"/> Sinkhole/Void	Diameter:				Depth:		
<input type="checkbox"/> Other							
Describe the potential Levee Threat:							

REVISIONS			
REV	DESCRIPTION	DATE	APPROVED



### CROSS-SECTION SKETCH

**Directions:** Please include soil profiles, slope armoring, pipelines, conduits, utility lines, any additional features that may assist in assessing the levee, any additional notes to the best of your ability, and all relative elevations including water surface elevation at time of site visit, recent high water surface elevation (if evident), and original landside ground elevation. If seepage or stability is a concern, please include seepage path or failure surface.

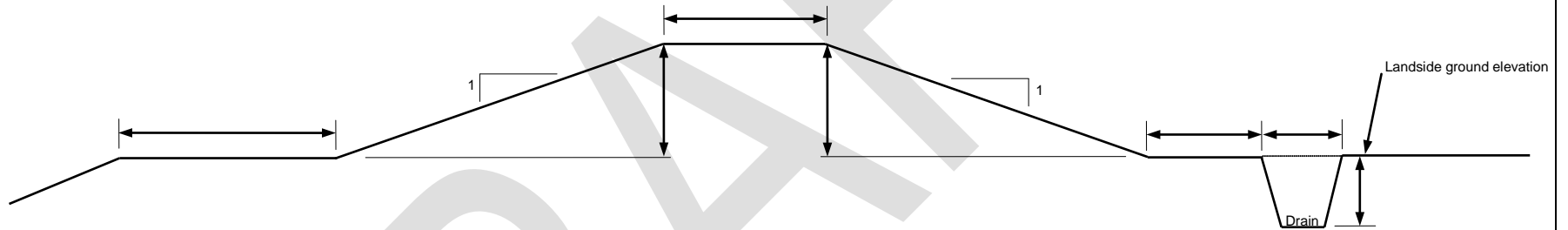

<b>Waterside Slope:</b>		<b>Crown Width:</b>	
<b>Waterside Height:</b>		<b>Relative Crown Elevation:</b>	
<b>Landside Height:</b>		<b>Relative Water Surface Elevation:</b>	
<b>Landside Slope:</b>		<b>Relative Landside O.G. Elevation:</b>	
<b>Upstream/Downstream Gage:</b>		<b>Upstream/Downstream:</b>	
<b>Describe method/technique used to mark and measure. Select tools utilized:</b>	<input type="checkbox"/> Tape <input type="checkbox"/> Laser Level <input type="checkbox"/> Sight Level <input type="checkbox"/> Surveying Rod <input type="checkbox"/> Total Station <input type="checkbox"/> Other		

See Levee Threat Monitoring Guidelines for suggestions.

REVISIONS			
REV	DESCRIPTION	DATE	APPROVED



**PLAN VIEW SKETCH**

**Directions:** Please include all dimensions, slopes, grade breaks, water edge, original landside ground elevation, pipelines, conduits, utility lines, encroachments, any additional features that may assist in assessing the levee, and any additional notes. Indicate north direction in the space provided.

DRAFT



REVISIONS			
REV	DESCRIPTION	DATE	APPROVED



SITE HISTORY AND LEVEE THREAT	
<p><b>History of Affected Area:</b> <i>Please include past reports on problem if available.</i></p>	
<p><b>Underlying Cause of Threat:</b> <i>Examples include poor construction, additional loading, levee geometry, poor soils, etc.</i></p>	
<p><b>Current Flood Fight Methods to Mitigate Threat:</b></p>	

GEOTECHNICAL ASSESSMENT																	
<p><b>Soil Description:</b> <i>Describe how this information was obtained for example by observation, boring logs, lab testing, etc.</i></p>																	
<p><b>How does the levee soil or foundation soil type impact a potential levee threat?</b></p>																	
<p><b>Recommendations for further soil testing:</b> <i>Select all that apply and provide a justification as to why that testing method is necessary.</i></p>	<table style="width: 100%; border: none;"> <tr> <td style="width: 50%; border: none;"><input type="checkbox"/> Sieve Analysis</td> <td style="width: 50%; border: none;"><input type="checkbox"/> Standard Penetration Test</td> </tr> <tr> <td style="border: none;"><input type="checkbox"/> Hydrometer Analysis</td> <td style="border: none;"><input type="checkbox"/> Cone Penetration Test</td> </tr> <tr> <td style="border: none;"><input type="checkbox"/> Atterberg Limits</td> <td style="border: none;"><input type="checkbox"/> Boreholes</td> </tr> <tr> <td style="border: none;"><input type="checkbox"/> Permeability</td> <td style="border: none;"><input type="checkbox"/> Test Pits</td> </tr> <tr> <td style="border: none;"><input type="checkbox"/> Direct Shear</td> <td style="border: none;"><input type="checkbox"/> Inclinator</td> </tr> <tr> <td style="border: none;"><input type="checkbox"/> Triaxial Compression</td> <td style="border: none;"><input type="checkbox"/> Extensometer</td> </tr> <tr> <td style="border: none;"><input type="checkbox"/> Unconfined Compression</td> <td style="border: none;"><input type="checkbox"/> Land Surveys</td> </tr> <tr> <td style="border: none;"><input type="checkbox"/> Standard Penetration Test</td> <td style="border: none;"><input type="checkbox"/> Other</td> </tr> </table>	<input type="checkbox"/> Sieve Analysis	<input type="checkbox"/> Standard Penetration Test	<input type="checkbox"/> Hydrometer Analysis	<input type="checkbox"/> Cone Penetration Test	<input type="checkbox"/> Atterberg Limits	<input type="checkbox"/> Boreholes	<input type="checkbox"/> Permeability	<input type="checkbox"/> Test Pits	<input type="checkbox"/> Direct Shear	<input type="checkbox"/> Inclinator	<input type="checkbox"/> Triaxial Compression	<input type="checkbox"/> Extensometer	<input type="checkbox"/> Unconfined Compression	<input type="checkbox"/> Land Surveys	<input type="checkbox"/> Standard Penetration Test	<input type="checkbox"/> Other
<input type="checkbox"/> Sieve Analysis	<input type="checkbox"/> Standard Penetration Test																
<input type="checkbox"/> Hydrometer Analysis	<input type="checkbox"/> Cone Penetration Test																
<input type="checkbox"/> Atterberg Limits	<input type="checkbox"/> Boreholes																
<input type="checkbox"/> Permeability	<input type="checkbox"/> Test Pits																
<input type="checkbox"/> Direct Shear	<input type="checkbox"/> Inclinator																
<input type="checkbox"/> Triaxial Compression	<input type="checkbox"/> Extensometer																
<input type="checkbox"/> Unconfined Compression	<input type="checkbox"/> Land Surveys																
<input type="checkbox"/> Standard Penetration Test	<input type="checkbox"/> Other																

REVISIONS			
REV	DESCRIPTION	DATE	APPROVED



RIVER CONDITIONS					
<b>Upstream Gage:</b>	<b>Date:</b>		<b>Downstream Gage:</b>	<b>Date:</b>	
	<b>Time:</b>			<b>Time:</b>	
	<b>Stage:</b>			<b>Stage:</b>	
<sup>2</sup> <b>Current River Stage at Site of Levee Threat:</b>			<b>Datum:</b>		
<sup>2</sup> <b>Forecasted River Stage at Official Forecast Point:</b>			<b>Current Weather Conditions:</b>		
<b>Flow Velocity:</b>			<b>Forecast Weather Conditions:</b>		
<b>River-Stream Forecast:</b>	<input type="checkbox"/> Water level is forecast to recede <input type="checkbox"/> Water level is forecast to remain the same <input type="checkbox"/> Water level is forecast to increase				
<b>Water Level:</b>	<input type="checkbox"/> Current and forecasted river stage as compared to the adjacent landside ground elevation is such that no structures or public roads would be impacted <input type="checkbox"/> Current and forecasted river stage as compared to the adjacent landside ground elevation is such that few structures and public roads would be impacted <input type="checkbox"/> Current and forecasted river stage as compared to the adjacent landside ground elevation is such that numerous structures and public roads would be impacted				

<sup>2</sup> Use <http://cdec.water.ca.gov> and <http://www.cnrc.noaa.gov>

IDENTIFY CRITICAL INFRASTRUCTURE			
<b>Indicate critical infrastructure levee is protecting taking into consideration current and forecasted river stage:</b>			
<b>Public Roads:</b>		<b>Potential Inundation Acreage:</b>	

REVISIONS			
REV	DESCRIPTION	DATE	APPROVED





INITIAL ASSESSMENT/FAILURE ANALYSIS	
<b>Failure Mode Description:</b> (Sloughing, erosion, seepage, etc.)	
<sup>3</sup> Describe the progression (failure rate) of levee threat and methods used to measure progress:	
Indicate the threshold to predict levee failure. Provide an explanation for threshold and value.	
<b>Degradation Rate:</b>	<input type="checkbox"/> Degradation rate is slow, and it will not affect the structural stability of the levee. It will likely withstand during the upcoming flood season <input type="checkbox"/> Degradation rate is moderate and potential failure is expected within five (5) days. <input type="checkbox"/> Degradation rate is critical and potential failure is expected within forty-eight (48) hours.
<b>Levee Threat &amp; Flood Fight Methods:</b>	<input type="checkbox"/> The levee has a high probability of keeping water contained within the waterway during the flood season under existing and forecast conditions without placement of flood fight materials. Flood fight methods, other than monitoring, are not necessary. <input type="checkbox"/> The levee may not be able to keep water contained within the waterway without the placement of flood fight materials (sandbags & plastic) to mitigate the levee threat <input type="checkbox"/> The levee cannot contain water within the waterway without placement of emergency repair materials. Flood fight methods cannot mitigate the threat due to the severity of existing and forecast conditions and more sustainable materials (rock and soil) are required.

<sup>3</sup> Please include any pertinent documents such as levee patrol logs and pictures to illustrate the progression of the levee threat.

REVISIONS			
REV	DESCRIPTION	DATE	APPROVED



RECOMMENDED MITIGATION/FLOOD FIGHT METHODS	
Recommended Action	Comment
<p><sup>4</sup> Please check all that apply.</p> <ul style="list-style-type: none"> <li><input type="checkbox"/> Monitor</li> <li><input type="checkbox"/> Riprap</li> <li><input type="checkbox"/> Embankment Fill</li> <li><input type="checkbox"/> Sandbag Ring</li> <li><input type="checkbox"/> Other</li> <li><input type="checkbox"/> Sack Topping</li> <li><input type="checkbox"/> Temporary Levee</li> <li><input type="checkbox"/> Lumber and Sack Topping</li> <li><input type="checkbox"/> Sack Ring</li> <li><input type="checkbox"/> Envelope Method</li> <li><input type="checkbox"/> Raincoat Method</li> <li><input type="checkbox"/> Emergency Spillway Structure</li> <li><input type="checkbox"/> Protection/Diversion</li> <li><input type="checkbox"/> K-rail</li> <li><input type="checkbox"/> Sheet Piles</li> <li><input type="checkbox"/> Other</li> </ul>	
<p><sup>5</sup> Initial Engineer's Cost Estimate: <i>Include materials, quantities, equipment, method, and opinion of cost</i></p>	

<sup>4</sup> See Flood Fighting Methods for more information.

<sup>5</sup> Please include attachments when necessary.

RECOMMENDED LONG-TERM OR PERMANENT REPAIR	
<p><sup>6</sup> Include materials, quantities, equipment, method, and opinion of cost</p>	

<sup>6</sup> Please include attachments when necessary. This will not be performed by the State-Federal Flood Operations Center, but may be considered by the programmatic levee repair program within the Department of Water Resources.

REVISIONS			
REV	DESCRIPTION	DATE	APPROVED



**ADDITIONAL NOTES**

**Directions:** Please provide any pertinent information that may be helpful in assessing this levee threat. Photos, maps, and any other attachments are encouraged.

DRAFT

REVISIONS			
REV	DESCRIPTION	DATE	APPROVED



**State of California Natural Resources Agency  
Department of Water Resources  
DIVISION OF FLOOD MANAGEMENT**

**ENGINEERING CERTIFICATION**

This assessment has been prepared under my direction as the professional engineer or certified engineering geologist in direct responsible charge of the work, in accordance with the provisions of the Professional Engineers' Act or the Geologist and Geophysicist Act of the State of California.

P.E. or C.E.G. Stamp

\_\_\_\_\_  
Address

\_\_\_\_\_  
Phone Number

\_\_\_\_\_  
Company

\_\_\_\_\_  
Printed Name

\_\_\_\_\_  
Signature

\_\_\_\_\_  
Date

REVISIONS			
REV	DESCRIPTION	DATE	APPROVED

**Appendix N**  
**Levee Threat Monitoring Guidelines**

# Levee Threat Monitoring Guidelines



State of California  
Department of Water Resources  
2012 Edition

---

# Levee Threat Monitoring Guidelines

---

State of California  
California Natural Resources Agency  
Department of Water Resources



Division of Flood Management  
Flood Operations Branch  
April 2012

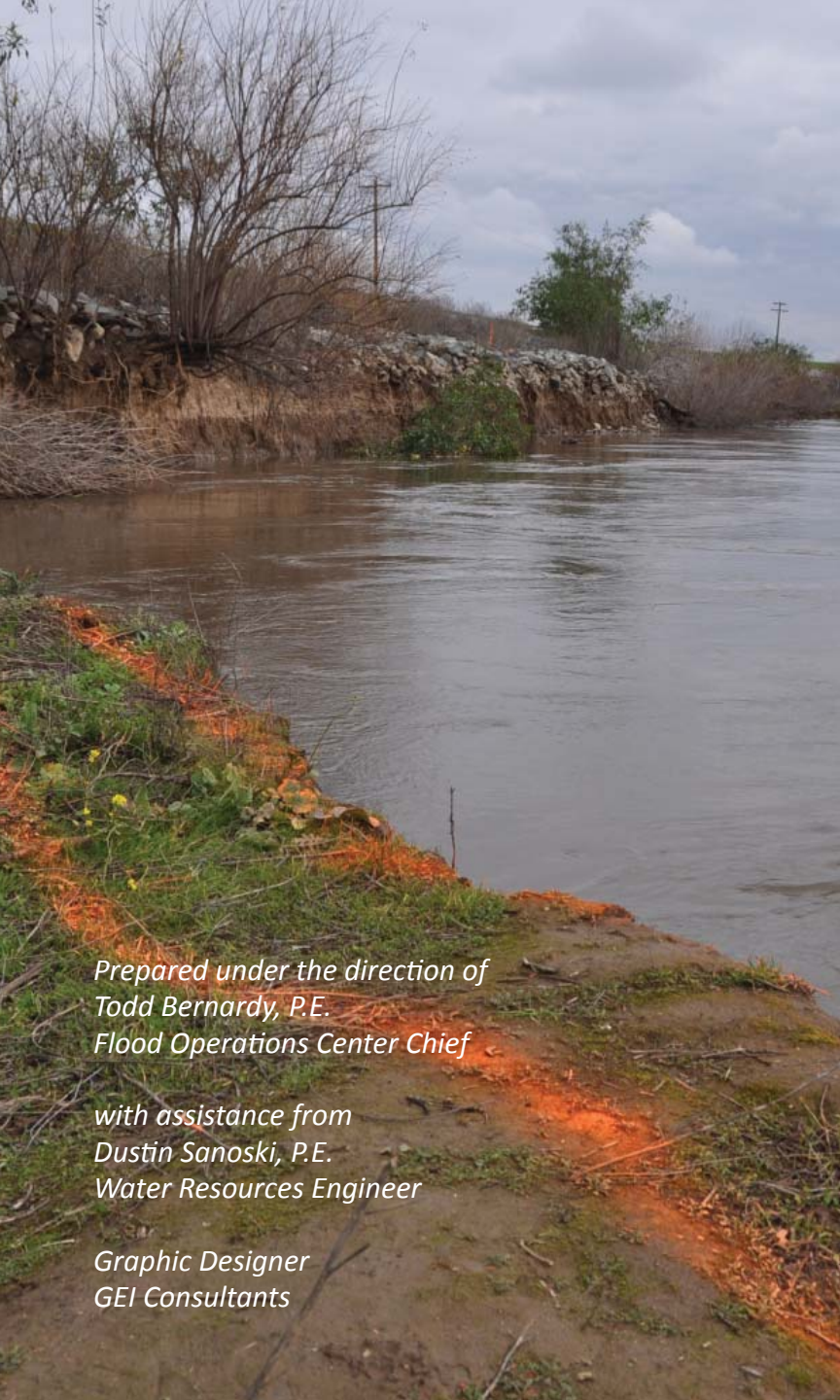

*Prepared under the direction of  
Todd Bernardy, P.E.  
Flood Operations Center Chief*

*with assistance from  
Dustin Sanoski, P.E.  
Water Resources Engineer*

*Graphic Designer  
GEI Consultants*



# TABLE OF CONTENTS

---

Introduction .....	2
Levee and Embankment Threats .....	3
Patrolling .....	3
Terminology .....	4
Material Supplies Checklist .....	6
Gear Checklist.....	6
Lath Labeling Example.....	7
Field Safety Measures .....	8
Preparedness.....	11
Seepage.....	12
Boil .....	14
Sink Hole.....	16
Cracking .....	18
Slope Instability .....	20
Wave Wash .....	24
Erosion .....	26
Special Thanks.....	29
Reference Guide .....	30
Levee Cross Section .....	31



## *Introduction*

The purpose of the Levee Threat Monitoring Guidelines is to establish a set of “Best Practices” based on field-tested techniques used by levee maintaining agencies, their engineers, flood fight specialists, and levee inspectors to mark and monitor a levee threat.

These guidelines seek to “standardize” levee threat monitoring techniques and are NOT to be taken as requirements. This standardization will help ensure the threat is properly communicated to the appropriate groups, such as emergency responders and the Flood Operations Center. Particularly when there are multiple threats during a high water event, the ability to communicate effectively becomes especially important when the number of potential threats exceeds the available (limited) resources to respond, and a priority must be placed on which threat to mitigate first.

The Levee Threat Monitoring Guidelines presented in this field book were developed by the Department of Water Resources (DWR) Division of Flood Management in cooperation with the local maintaining agencies, experienced consultant engineers, and DWR maintenance yards.

## *Levee and Embankment Threats*

The main causes of levee failure or flood related problems due to high water are:

- **Seepage** of water carrying material through or under the levee heavy enough to cause a “boil”.
- **Erosion** of the levee or embankment due to swift moving water or wave action.
- **Overtopping** resulting from water-surface elevations higher than the levee or embankment.

## *Patrolling*

The best defense against flood related issues or levee failure is to identify problems early and repair them immediately. Levee inspections and effective high water patrolling make this possible. The following suggestions will help in organizing patrol teams for this work:

- Operate under the SEMS/ICS system and report to the appropriate section chief.
- Provide a sufficient number of workers for two 12-hour shifts.
- Provide each worker with a copy of the DWR “Flood Fighting Methods” handbook.
- Assign two people to each mobile patrol.
- Advise the officials of the district or agency responsible for emergency assistance in the area, and if necessary request the help from their Operational Area.

## Terminology

Boil	Also known as “sand boil”, is caused by water flowing through or under a levee, possibly carrying eroded levee material, and surfacing on the land side of the levee.
Cracking	Fracture on the top or slope of a levee caused by displacement of the embankment material. Excessive cracking can lead to slipping/sliding (clay soils) or sloughing (silty or sandy soils).
Erosion	Removal of levee material from the toe or slope of the levee due to swift moving water or wave action possibly resulting in bank caving, section loss, or levee break.
Flood Fighting	An effort made to prevent or mitigate the effects of flood waters.
Hub	A wooden stake (1-1/2”x1-1/2”x8”) that is pounded into the ground as a place-holder (optional) for lath with only a few inches exposed and sprayed at the top with high visibility marking paint.
Lath	Long, narrow wooden stakes (1/4”x1-1/2”x33”) used to mark problem areas during high water patrolling. A brief description of the problem along with the date, time, and patroller’s initials are written on the lath with a permanent ink marker. Brightly colored survey ribbon is attached to the lath for easy identification.
Levee	An earthen structure that parallels a river or stream designed to prevent high water flows from inundating urban and/or agricultural land.
Levee Break	A point in the levee system that has failed to perform its designed function, has eroded away and is allowing water to inundate land.

Levee Breach	The same as “Levee Break” but can sometimes describe a section of levee that has been intentionally broken. If intentional, also known as a relief cut.
Overtopping	When water has risen higher than the banks of a waterway or the top of a levee.
Plastic Sheeting	Made of polyethylene; these 100’x20’x10-mil rolls are sometimes referred to as visquine and are commonly used for erosion control.
Relief Cut	Intentionally removed section of levee to relieve hydrologic pressure upstream and downstream of the levee section.
Sack Ring	Multiple sandbags used to encircle a boil, slow the flow of water, and stop the erosion of levee material.
Sandbag	An 18”x30” bag (burlap or plastic) filled with sand or other appropriate material intended for use as a temporary flood fighting measure.
Scarp	A steep slope or long cliff that occurs from erosion or faulting and separates two relatively level areas of differing elevations.
Seepage	Water traveling under or through a levee in the void spaces of the soil.
Slope Instability	Soil movement or slip/slides often caused by over-saturated levee slopes or hillside slopes. Can also be referred to as “sloughing” or “mud slides”.
“U” Shaped Sack Ring	A sandbag structure used on levee slopes to control boils.

## ***Material Supplies Checklist:***

- Lath (1/4"x1-1/2"x33")(25)
- Stakes (3/4"x1-1/2"x17")(25)
- Hubs (1-1/2"x1-1/2"x8")(10)
- 6' Rebar w/ Plastic Caps (2 No. 4 Rebar)
- Tie Wire
- Survey Ribbon (Bright Colors, Multiple Rolls)
- Sandbags (approximately 50 empty)
- Plastic Sheeting (Visquine) (1 roll)
- Box Twine (250lb tensile strength)
- Tie Down Buttons (approximately 100)
- Barricade or Safety Cones (Fluorescent Orange)
- Permanent Ink Markers
- High Visibility Marking Paint (17.0 oz)

## ***Gear Checklist:***

- First Aid Kit
- Personal Flotation Device
- Throw Rope
- Directory of Flood Officials & Flood Emergency Phone Card
- Log Book
- GPS
- Phone or Radio
- Rain Gear
- Boots or Rubber Boots
- Hard Hat
- Safety Glasses or Goggles
- Gloves
- Hip Waders
- Spot Light
- Pliers
- Tape Measure (100')
- Bolt Cutter
- Tow Chain
- Chain Saw or Axe
- Flashlight w/ Batteries
- Shovels, Long Handle (#2 Mud Shovel)
- Sledge Hammer (5 or 8 lb)
- Camera

# Lath Labeling Example

**High Visibility Marking Paint** → (top 6" minimum)

**Survey Ribbon** – use bright colors and double-up for extra visibility and redundancy (Tie it, wrap it around, and tie it again) →

**Provide Date and Time** (24-hr) as reference for determining rates (i.e. rate of decay, flow rate, etc.) →

**Provide Initials** to reference patroller →

**Threat** being monitored →

**Pertinent information** being used to describe threat (i.e. flow rate, offset distance, horizontal/vertical displacement, etc.) →



## Field Safety Measures

- **Check Weather Patterns:** Always know weather forecasts and how it affects the vulnerable areas.
- **Changing Water Patterns:** The rise and fall of water can occur gradually or very quickly. Knowledge of high water and how it relates to your sites/levees is essential. Continuous monitoring and communication of water level influences, (i.e. reservoir releases, tides, and drainage inflow) is very important. Always know your area and its flood history.
- **Swift Water:** High velocities of water are common during high water events. Extreme caution should be used when anyone is exposed to high water. Workers must have personal flotation devices, throw ropes, and lifelines in the immediate area. Each staking crew must be composed of at least two individuals when staking swift water areas. Use common sense and sound judgment around swift water. Know your resources and how to activate them prior to the event. Swift water rescue teams may be available.
- **Temperature Related Illness:** Weather patterns can change constantly. Changes in temperature present the potential for hypothermia and heat exhaustion/stroke. Levee monitors should know the signs of distress for these types of illnesses and how to treat them. During cold, wet weather, it is recommended that workers layer clothing to stay warm and dry. A dry blanket and warm clear fluids should be on the work site for emergency use. In warm/hot weather lightweight clothing is recommended. If skin is exposed, a sun block agent may need to be applied. Plenty of drinking water should be on site and consumed regularly. Headgear is recommended in both hot and cold situations.
- **Insect/Animal Exposure:** Flooded areas force a variety of animals to evacuate to high ground. Workers in these areas should be aware of these animals and not handle them. If animal removal is needed, contact a local professional. Stinging and biting insects are prominent in certain flood-prone areas. Chemical repellents can be useful as a deterrent. A complete first aid kit should be on site.



- **Vegetation:** Noxious plants such as star thistle, stinging nettle, and poison oak are commonly found along rivers, streams, and levees. Avoid direct contact with this type of vegetation to prevent itching and rash. Consult medical personnel if symptoms persist. Individuals with history of allergic reaction should consider carrying an EpiPen.
- **Contamination:** Flooded areas can potentially carry high levels of contaminants. Common contaminants include fuel, sewage, and pesticides. Local Haz-Mat teams should be contacted if needed. Always wear protective clothing to help limit contact with water. Carry antibacterial hand soap and wash thoroughly after working around flood water.
- **Construction Equipment:** There are times when equipment and people will occupy the same work area. Workers should wear safety vests and hard hats and be aware of their surroundings. Safety warning devices (i.e. backup alarms and lights) should be intact and working on all equipment. Keep a battery-operated flashlight and radio on hand. Communication and alertness are vital! All operators must be certified for their equipment.
- **Boat Travel:** Materials and/or personnel will sometimes need to be transported to work sites by boat. Operators of the watercraft must be certified. Personal flotation devices must be available for every passenger. Extreme care should be taken while loading and off loading.
- **Patrolling:** Patrols will identify, mark, and monitor trouble spots in affected areas. Vehicle patrols should travel in two person teams with dependable communication devices. Lifelines, personal flotation devices, and a blanket should be in the vehicle for possible water-related accidents. Foot patrols should also have the same considerations. Extreme caution should be exercised when travelling saturated, cracked, or sloughing areas. Learn first-aid and have a first-aid kit with you at all times. Never turn your back on the water - work facing the water whenever possible or have a spotter monitor it for you if necessary. Do not take actions that would put an individual in harm's way.

- **Structure Considerations:** When working around structures be aware of downed power lines, natural gas or propane leaks, and unstable structure supports. Communicate with the structure owner if possible.
- **Vehicle Considerations:** Vehicles along the levee should remain parked on high ground; this is usually the crown of the roadway. Vehicles should also be parked facing their access point to allow for a quick exit (if possible). An escape plan should be communicated to all flood workers prior to heading out into the field. Do not drive through floodwaters during high water events. Remember, two feet or less of water can cause a car to be swept away.



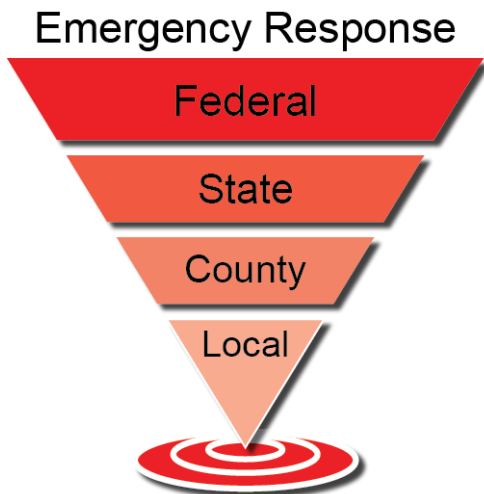

Every emergency begins at the local level. Be prepared and have an emergency action plan!

- Patrol plan & schedule
- Emergency contacts & calling tree
- Emergency response protocols for monitor, flood, danger stage, and incident
- Location and quantities of flood fight materials
- Location and type of equipment available
- Evacuation plan and rally point
- List of critical sites that need extra attention
- Location & contact information for county Emergency Operations Center (EOC)

Share your emergency action plan with your local county Office of Emergency Services and DWR Flood Operations Center.

# SEEPAGE

## *Considerations Around Seepage*

1. Do not park directly above the area of seepage.
2. Do not tread unnecessarily near the area of seepage.
3. The sensitive zone may be saturated—do not walk directly from the road straight down to the area of seepage.
4. Confirm the seepage is NOT caused by an irrigation pipe.

## *What to Measure and Record in Log Book*

Monitor changes in the extent of seepage and transport of material.

- Date, Time, Person's Name
- Location along levee (GPS coordinates, levee mile, or approximate description) – use lath ② for reference
- Description of threat:
  - » Offset distances from lath
  - » Approximate longitudinal length along levee
  - » Approximate pond width into field
  - » Material transport: flowing clear or carrying material
  - » Note if the water appears to be ponded or is flowing
  - » Extent of soil saturation up the levee toe
  - » Note signs of slope instability
  - » Approximate water surface elevation relative to crown
  - » Note forecast point staff gage reading
  - » Note past performance history of site
- Note surrounding ground conditions & signs of poor drainage
- Take photos or draw schematic for records



# How to Mark Seepage

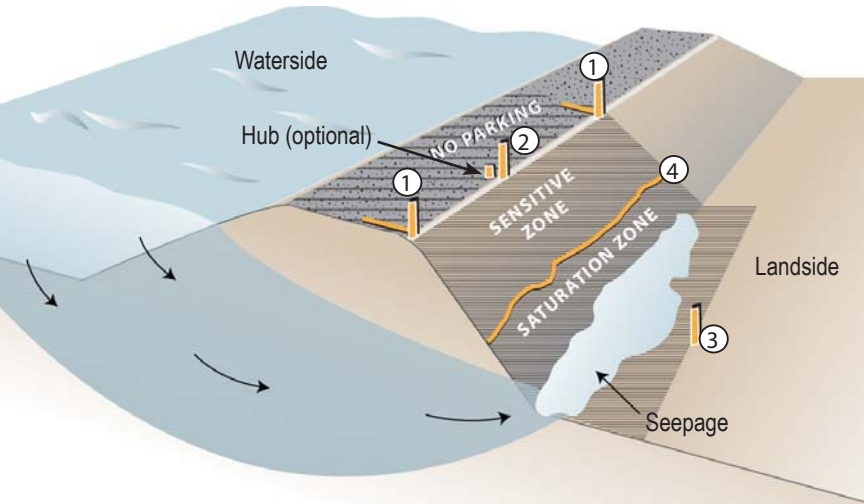

- Place one lath at the beginning of the ponding location and one at the end. Mark each lath with an arrow pointing inwards toward the location of ponding. Mark whether the water appears to be clear or carrying material. Add lath as the threat grows (do NOT remove old lath). Paint can be used as an alternative to placing lath.



- Mark the longitudinal length and width of the ponding along the levee. Place an optional hub at the base of the lath to identify the location of the threat in case the lath becomes lost or stolen.



- Lath alternative: Place an additional lath in the landside field at the extent of ponding.



- Saturation zone (if weather permits): Draw a line up and along the levee slope using high visibility marking paint to display the edge of the saturation zone. Paint date next to line.

**\*\*Replace lath if lost or stolen\*\***

## *Considerations Around Boil*

1. Do not park directly above the boil.
2. Do not tread unnecessarily near the boil.
3. The sensitive zone may be saturated—do not walk directly from the road straight down to the boil.
4. Confirm the boil is NOT caused by an irrigation pipe.

## *What to Measure and Record in Log Book*

Monitor changes in water flow rate and transport of material.

- Date, Time, Person's Name
- Location along levee (GPS coordinates, levee mile, or approximate description) – use lath ① for reference
- Description of threat:
  - » Located on levee slope or ground adjacent to slope
  - » Offset distances from lath
  - » Distance from levee toe
  - » Diameter of boil(s) & total number of boils
  - » Material transport: water flowing clear or carrying material
  - » Approximate flow rate (i.e. 1 cup/min, 1 coffee can/min, 5-gallon bucket/min)
  - » Approximate water surface elevation relative to crown
  - » Note forecast point staff gage reading
  - » Note past performance history of site
- Note surrounding ground conditions & signs of poor drainage
- Take photos or draw schematic for records



# How to Mark a Boil

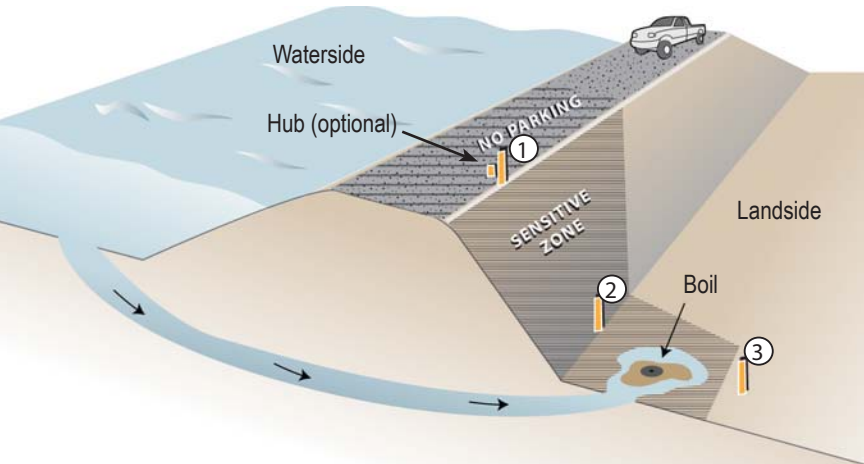

- ① Mark the diameter of the boil and the approximate flow rate. Place an optional hub at the base of the lath to identify the location of the threat in case the lath becomes lost or stolen.



- ② Measured from the levee toe, mark the distance to the edge and to the center of the boil. Place this lath when boil is located far from toe.

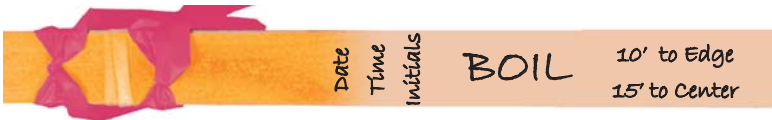

- ③ Lath alternative: Place an additional lath in the landside field at a minimum distance of 10' from the boil edge to show extent of ponding.



Optional measure: If there is a question about source of boil, use environmentally safe dye in adjacent irrigation channels to confirm water flow is from river.

**\*\*Replace lath if lost or stolen\*\***

# SINK HOLE

## *Considerations Around Sink Hole*

1. Do not park directly adjacent to sink hole.
2. Be cautious of collapse around sink hole.
3. Be cautious around toe of levee slope.
4. Confirm the sink hole is NOT caused by an irrigation pipe.

## *What to Measure and Record in Log Book*

Monitor changes in diameter, depth of sink hole, and water level.

- Date, Time, Person's Name
- Location along levee (GPS coordinates, levee mile, or approximate description) – use lath ① for reference
- Description of threat:
  - » Location of threat (landside, waterside, crown, slope, toe)
  - » Offset distances from lath
  - » Diameter of sink hole
  - » Note if sink hole is dry or filled with water
  - » Use a lath to approximate the depth of water
  - » Note if pipes, risers, valves or other appurtenances are present.
  - » Approximate water surface elevation relative to crown
  - » Note forecast point staff gage reading
  - » Note past performance history of site
- Take photos or draw schematic for records





# How to Mark Sink Hole

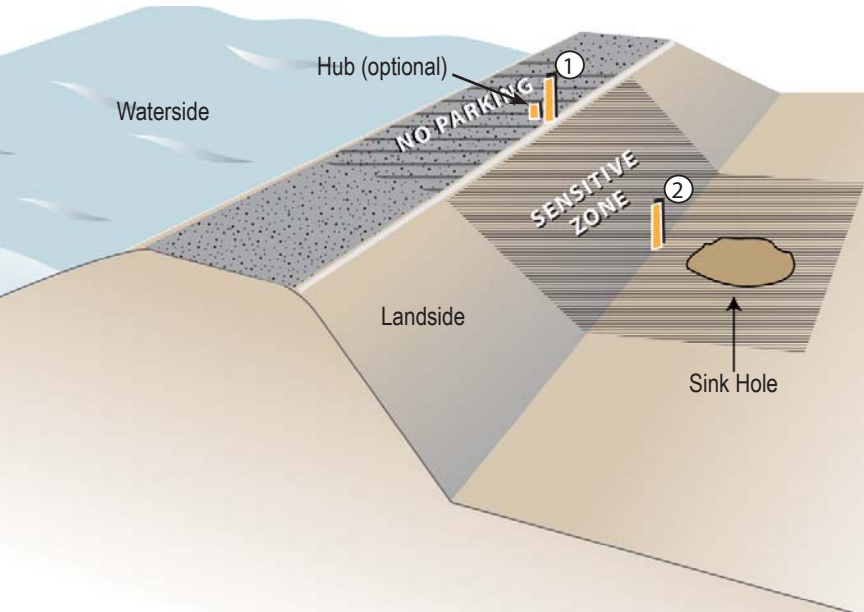

- ① Mark the diameter of the sink hole. Place an optional hub at the base of the lath to identify the location of the threat in case the lath becomes lost or stolen.



- ② Measured from the levee toe, mark the distance to the edge and to the center of the sink hole. Place this lath when sink hole is located far from toe.



**\*\*Replace lath if lost or stolen\*\***

# CRACKING

## *Considerations Around Cracking*

1. Do not park directly on the cracks.
2. Place lath 1' offset from cracks (typical).

## *What to Measure and Record in Log Book*

Monitor change in length, width, depth, and extent into crown.

- Date, Time, Person's Name
- Location along levee (GPS coordinates, levee mile, or approximate description) - use lath ② for reference
- Description of threat:
  - » Location of threat (landside, waterside, crown, slope)
  - » Offset distances from lath or paint
  - » Longitudinal length of cracking
  - » Width of cracking into crown
  - » Largest crack width
  - » Largest depth in crack
  - » Note bulging or instability on levee slope
  - » Approximate water surface elevation relative to crown
  - » Note forecast point staff gage reading
  - » Note past performance history of site
- Take photos or draw schematic for records



# How to Mark Cracking

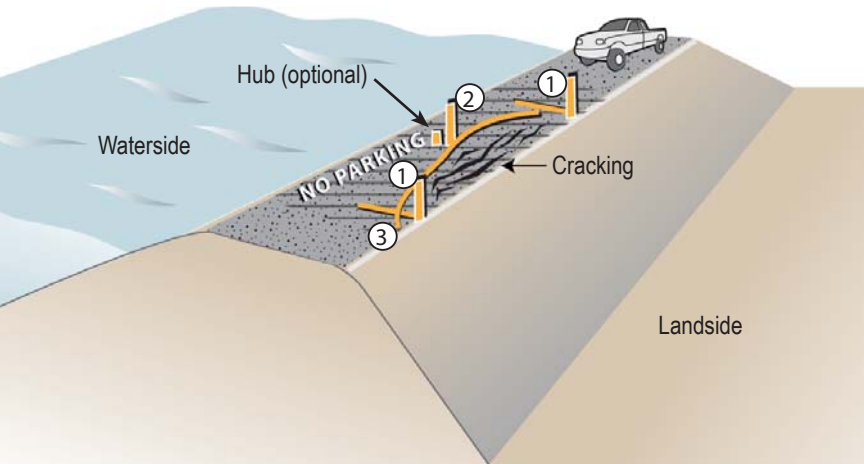

- Place one lath at the beginning of the cracking and one at the end. Mark each lath with an arrow pointing inwards toward the location of the threat. Mark the largest width and depth of cracking. Add lath as the threat grows (do NOT remove old lath). Paint can be used as an alternative to placing lath.



- Place one lath at the center location of cracking- beyond the area of cracking and adjacent to the affected area of the levee. Mark the longitudinal length of cracking; also mark the extent onto the crown if the cracking is occurring on the crown. Place an optional hub at the base of the lath to identify the location of the threat in case the lath becomes lost or stolen.



- Paint alternative (if weather permits): Draw a line adjacent to the cracking using high visibility marking paint. This will aid in visually displaying the area of cracking. Paint date next to line. Use in addition to the placing and marking of lath.

**\*\*Replace lath if lost or stolen\*\***

# SLOPE INSTABILITY

## *Considerations Around Slope Instability*

1. Do not park directly above unstable slope.
2. Barricade/cone the area if more than  $\frac{1}{4}$  crown width (horizontally) or more than 2' of vertical displacement has occurred (severe case). Place lath 2' offset from threat (typical).
3. Tread lightly in sensitive zone to prevent causing additional levee damage or injury to individual.

## *What to Measure and Record in Log Book*

Monitor movement of levee slope and record changes in horizontal and vertical displacement.

- Date, Time, Person's Name
- Location along levee (GPS coordinates, levee mile, or approximate description) – use lath ③ for reference
- Description of threat:
  - » Location of threat (landside crown, slope, toe)
  - » Offset distances from lath
  - » Longitudinal length
  - » Extent into crown
  - » Vertical displacement
  - » Horizontal displacement
  - » Note any bulging on levee slope
  - » Approximate water surface elevation relative to crown
  - » Note forecast point staff gage reading
  - » Note past performance history of site
- Take photos or draw schematic for records



## How to Mark Slope Instability

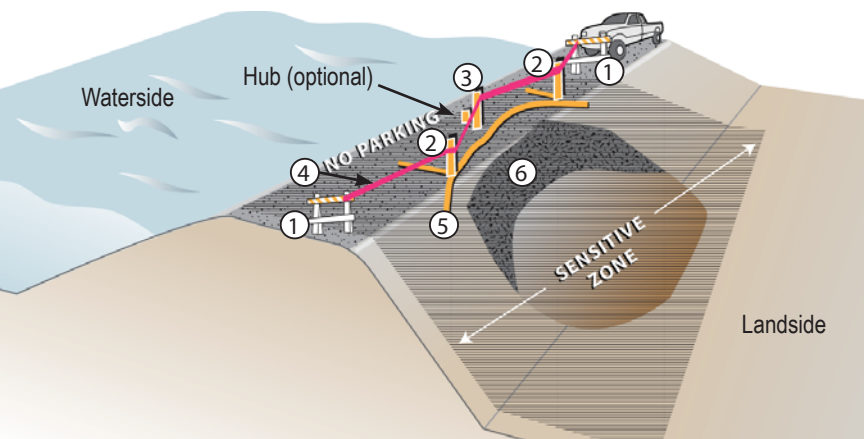

- ① Place barricade/cones 8' offset (minimum) from lath ②. Barricade/cones prevent vehicles from entering "danger zone" and are to be used in severe cases of horizontal and vertical displacement.
- ② Place one lath at the beginning of the slope instability (write "slip" on lath as a generic term to describe slope instability) and one at the end. Mark each lath with an arrow pointing inwards toward the location of the threat. Add lath as the threat grows (do NOT remove old lath). Paint can be used as alternative to placing lath.



- ③ Place a lath at the center location of slope instability. Mark the longitudinal length of the threat. Place an optional hub at the base of the lath to identify the location of the threat in case the lath becomes lost or stolen.



- ④ Ribbon connects the barricades to lath and encloses the "danger zone" from one side of the slope instability site to the other. Use bright colored ribbon to help make the site more visible.
- ⑤ Paint alternative (if weather permits): Draw a line adjacent to the edge of displacement using high visibility marking paint. This will aid in visually displaying the unstable site. Paint date next to line. Use in addition to the placing and marking of lath.
- ⑥ See page 22 for marking horizontal and vertical displacement.

**\*\*Replace lath if lost or stolen\*\***

# SLOPE INSTABILITY

## *How to Monitor Horizontal & Vertical Displacement*

1. Pound two laths vertically into stable section at a 1' offset from the moving section, 6" deep minimum, and space them 6" apart.
2. Secure one lath horizontally to the two lath on the stable section (as shown on next page) using tie wire or a comparable alternative. Stabilize lath using ground surface.
3. Pound one lath vertically into moving section approximately 6" deep, and offset 6" from the stable section. Place lath so that it rests against horizontal lath.
4. Draw a line on the vertical lath at the bottom of where it intersects with the horizontal lath. [This identifies the "baseline" for where to begin measuring vertical displacement]. Mark the date and time below this line.
5. Draw a line on the horizontal lath at the bottom of where it intersects with the vertical lath. [This identifies the "baseline" for where to begin measuring horizontal displacement]. Mark the date and time below this line.
6. Come back (some time later) and mark on the horizontal lath where it intersects with the vertical lath, and mark on the vertical lath where it intersects with the horizontal lath. Repeat this step over time as slope continues to displace.
7. Rate of horizontal & vertical displacement is the distance measured between observations divided by time.

# Early Stage Horizontal and Vertical Displacement

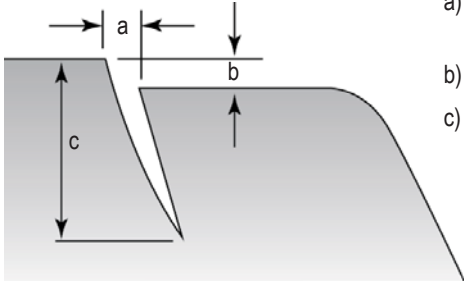

- a) Horizontal displacement
- b) Vertical displacement
- c) Crack depth

# Late Stage Horizontal and Vertical Displacement

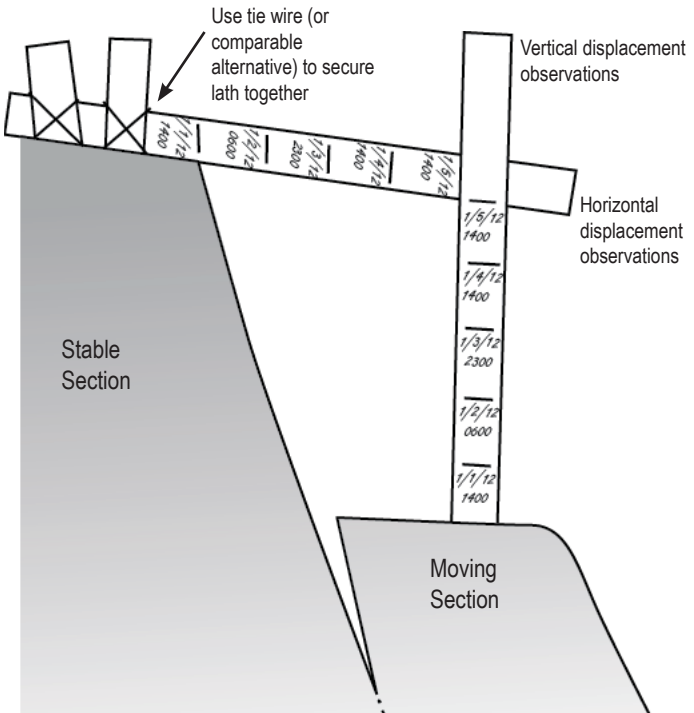

# WAVE WASH

## *Considerations Around Wave Wash*

1. Walk and drive carefully around areas subject to wave wash.
2. If wave wash results in erosion that encroaches into the levee prism it could lead to rapid levee failure.

## *What to Measure and Record in Log Book*

Monitor changes in length and expansion of erosion toward crown.

- Date, Time, Person's Name
- Location along levee (GPS coordinates, levee mile, or approximate description) – use lath ② for reference
- Description of threat:
  - » Distance down slope relative to crown
  - » Length and width(s) of erosion
  - » Height and depth of scarp
  - » Approximate water surface elevation relative to crown
  - » Note forecast point staff gage reading
  - » Note past performance history of site
- Take photos or draw schematic for records





# How to Mark Wave Wash

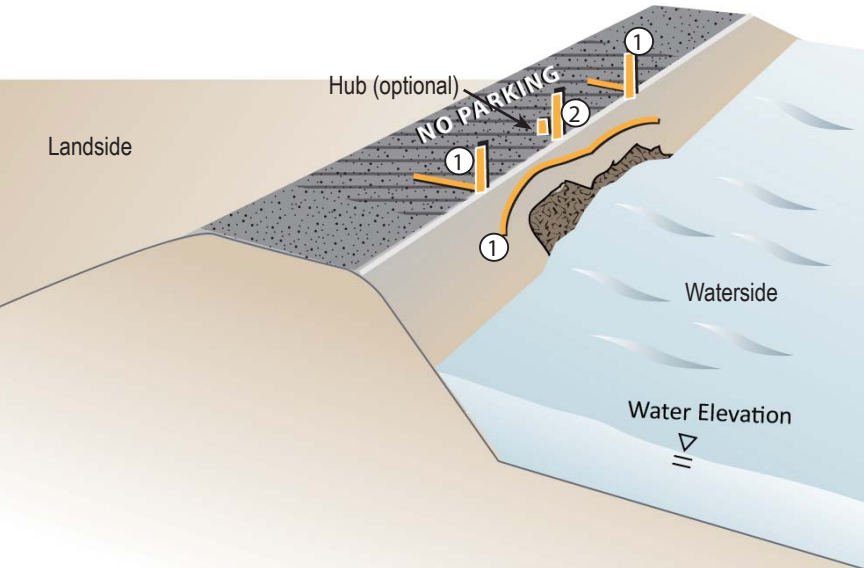

- ① Place one lath at the beginning of the area experiencing wave wash and one at the end. Mark each lath with an arrow pointing inwards toward the location of the threat. Add lath as the threat grows (do NOT remove old lath). Paint can be used as an alternative to placing lath.



- ② Mark the longitudinal length and width of the wave wash extent. Place an optional hub at the base of the lath to identify the location of the threat in case the lath becomes lost or stolen.



**\*\*Replace lath if lost or stolen\*\***

# EROSION

## *Considerations Around Erosion*

1. Walk and drive carefully around erosion site—loose soil could collapse and cause injury to person and/or vehicle.
2. If erosion encroaches into levee prism (see diagram) it could lead to rapid levee failure.
3. Be cautious near edge of erosion; eddy may have undermined bank integrity and may cave in unexpectedly.

## *What to Measure and Record in Log Book*

Monitor changes in length and expansion of erosion toward crown.

- Date, Time, Person's Name
- Location along levee (GPS coordinates, levee mile, or approximate description) – use lath ③ for reference
- Description of threat:
  - » Site relative to bend (straight, inside/outside)
  - » Offset distances from lath or paint
  - » Length and width(s) of erosion
  - » Height and depth of scarp
  - » Note if eddy has formed
  - » Approximate water surface elevation relative to crown
  - » Note forecast point staff gage reading
  - » Note past performance history of site
- Take photos or draw schematic for records



# How to Mark Erosion

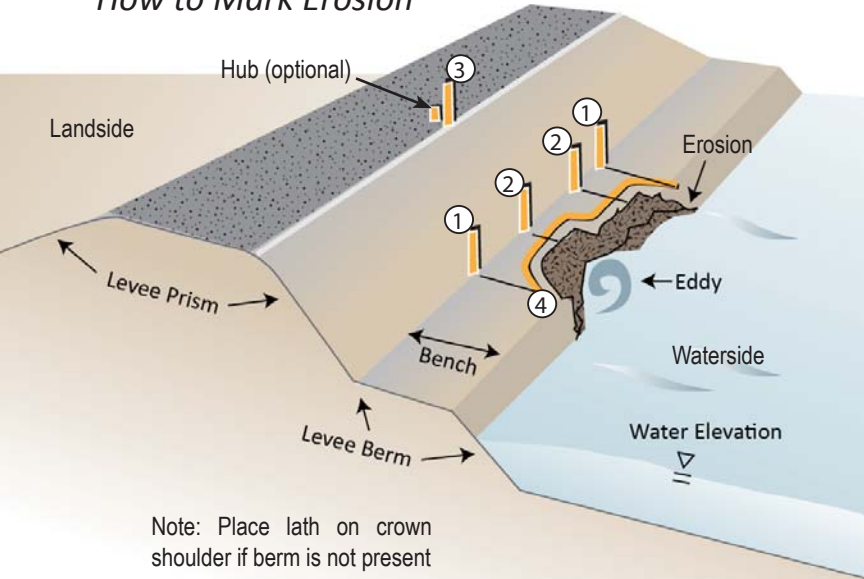

Note: Place lath on crown shoulder if berm is not present

- ① Mark offset distance from levee toe to edge of berm where no erosion has occurred – shows “normal” bench width and the extent of erosion. Place additional lath at levee toe as threat grows (do NOT remove old lath).

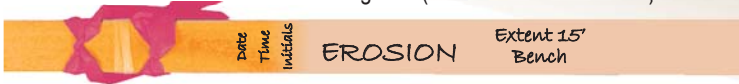

- ② Mark offset distance from levee toe to edge of erosion – shows depth of erosion into berm. Place lath at levee toe.



- ③ Place lath at levee crown shoulder and center it longitudinally across erosion site. Mark the longitudinal length of erosion. Place an optional hub at the base of the lath to identify the location of the threat in case the lath becomes lost or stolen.

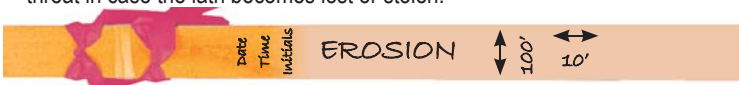

- ④ Paint alternative (if weather permits): Draw a line adjacent to the erosion, and several more in 4' increments away from the erosion, using high visibility marking paint. This will aid in visually displaying the rate of the erosion over time. Paint date next to line. Use in addition to the placing and marking of lath.

**\*\*Replace lath if lost or stolen\*\***

# EROSION

## *Monitor Erosion When Berm is Obscured*

If there is concern that the erosion site may be obscured due to water surface/stage increase, the berm can be monitored by placement of rebar. If rebar is gone, there is high likelihood that the erosion has grown to rebar location. One technique to monitor erosion when berm is obscured by water surface is described below:

1. Drive No. 4 rebar 2'-3' into ground no closer than 5' from current erosion edge.
  - » Be aware of potential for undercutting by eddys.
  - » Note location of rebar relative to levee toe and erosion edge.
2. Attach second No. 4 rebar to first rebar using tie wire so that the combined height of the two rebar are at least 6' above bench surface.
3. Attach 2 survey ribbons at the top of the second rebar.
4. To help protect the monitoring rebar against debris floating downstream, place three rebar upstream of monitoring rebar in a diagonally staggered line so to best deflect debris.
5. Document rebar location and distance from rebar to edge of erosion in log book.
6. Take photos or draw schematic for records.

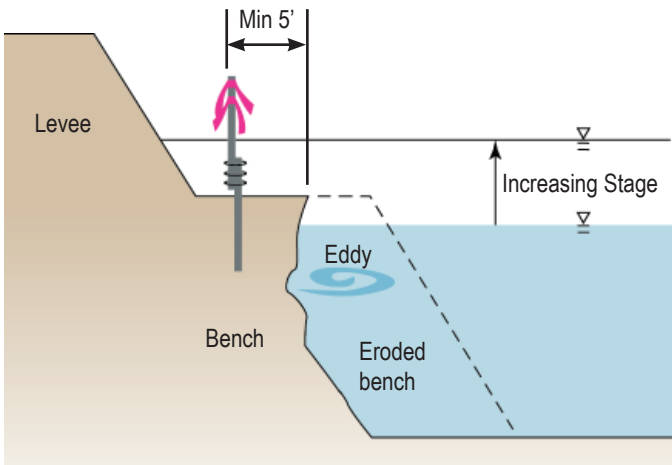

## *A Special Thank You to:*

### Flood Maintenance Office

Phil Carey  
Russ Eckman  
Mark List  
Eric McGrath  
Brian Murphy  
Ran Singh  
Jeff Van Gilder

### Flood Operations Branch

Rick Burnett  
Patricia Clark  
Nova Clemenza  
William Croyle  
Sean de Guzman  
Greg Harvey  
John Paasch  
Wendy Stewart  
Ally Wu

### Flood Project Integrity & Inspection Branch

Amy Bindra  
Tariq Chechi  
David Chen  
Bob Duffey  
Jim Eto  
Tasmin Eusuff  
Pavel Kazi  
Jaime Matteoli  
David Pesavento  
Herman Phillips  
Clay Thomas  
John Williamson

### Flood Risk Assessment and Mitigation Office

Vincent Rodriguez

### National Weather Service

Cindy Matthews

### Reclamation District 900

Tony Schwall

### San Joaquin County

Eric Ambriz  
John Nelson

## *Reference Guide:*

DWR Division of Flood Management:

**[www.water.ca.gov/floodmgmt](http://www.water.ca.gov/floodmgmt)**

California Data Exchange Center (CDEC)

**<http://cdec.water.ca.gov>**

California Emergency Management Agency (CalEMA)

**[www.calema.ca.gov](http://www.calema.ca.gov)**

National Weather Service

**[www.weather.gov](http://www.weather.gov)**

To request a copy of the Directory of Flood Officials or Flood Emergency Phone Card, contact the DWR Flood Operations Center at (916) 574-2619.

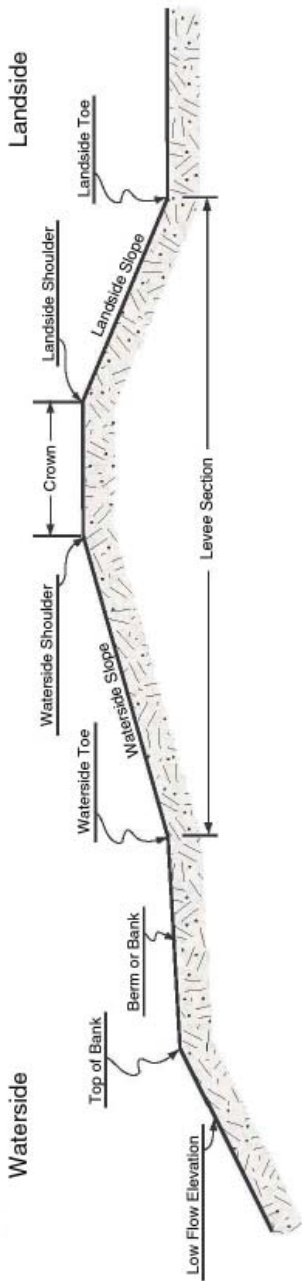

### Levee Cross Section

State of California  
 Department of Water Resources  
 Division of Flood Management  
 Flood Operations Branch

# FLOOD

EMERGENCY RESPONSE



For all flood emergencies, questions, or  
for additional information, please contact:

**State-Federal Flood Operations Center**

(916) 574-2619

(800) 952-5530

[flood\\_center@water.ca.gov](mailto:flood_center@water.ca.gov)



version 1.1





**Appendix O**  
**Levee Threat Mitigation Process**

November 2013

California Department of Water Resources  
*FLOOD EMERGENCY RESPONSE PROGRAM*

# Levee Threat Mitigation Process



PUBLIC SAFETY

ENVIRONMENTAL STEWARDSHIP

ECONOMIC STABILITY



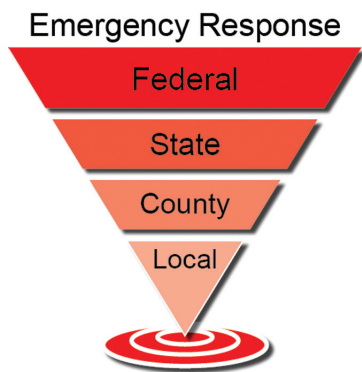

### Levee Threat Mitigation Process

Every emergency begins at the local level. The purpose of the Levee Threat Mitigation process (LTMP) is to clarify the roles and responsibilities of the State-Federal Flood Operations Center (FOC) and provide a guide to Local Maintaining Agencies (LMA), Operational Areas (OA), and other DWR Divisions for addressing flood threats as quickly as possible, using the Standardized Emergency Management System (SEMS) and the Incident Command Structure (ICS).

The Levee Threat Mitigation Process:

- Establishes common terminology and criteria for response
- Establishes responsibilities at local, county, and state levels
- Identifies requirements for requesting assistance

The following overview outlines the process needed to identify, assess, and respond to potential levee threats.

- **Step 1:** Threat Identification and Initial Assessment
- **Step 2:** Emergency Response
- **Step 3:** Imminent Threat Process
- **Step 4:** Non-Emergency Response

The **workflow diagram** outlines the main steps, and each step or decision has additional details, requirements, or additional information outlined in the **Supplemental Details** on the following pages.

### 1.0 Threat Identification and Initial Assessment

The purpose of this response level is to identify the potential levee threats and make an initial determination of immediate level of response (emergency, imminent threat, non-emergency). While DWR will continue to provide immediate support to emergency situations, some threats with longer lead times will require additional assessment for emergency response.

### 2.0 Emergency Response

The purpose of this response level is to make an immediate determination of the urgency of the threat. This is necessary to initiate the appropriate response which may include reassigning nearby resources from a lower response level. It is also necessary to prioritize the allocation of resources when there are multiple incidents occurring simultaneously. Emergency response can happen very quickly through communication techniques including phone calls and email. That being said, all documentation requirements must still be met, but may need to follow-up after the initial situation has been mitigated safely.

### Levee Threat Mitigation Process Workflow

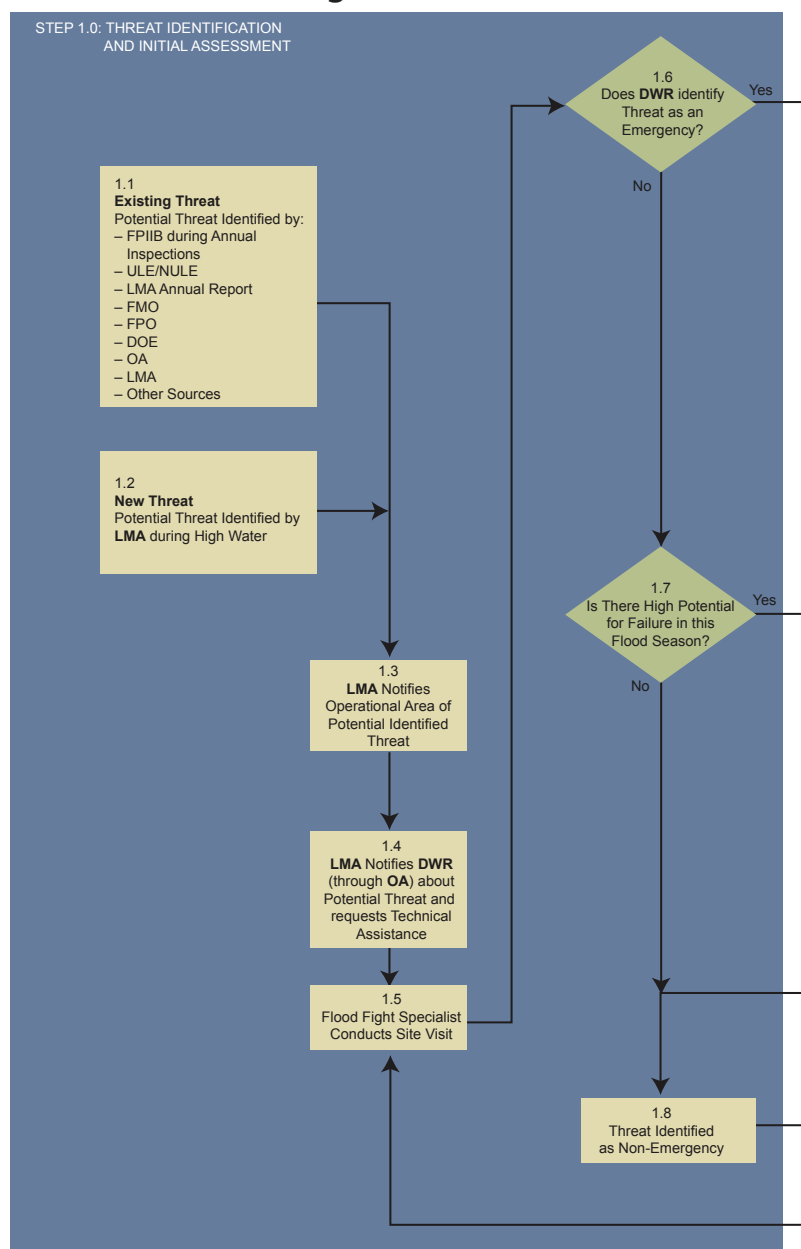

### 3.0 Imminent Threat Process

During the Imminent Threat Process, the levee threat has been determined to not immediately require an emergency response (potential failure within forty-eight (48) hours). The purpose of Imminent Threat Process is to develop additional information about the threat in order to determine that it meets imminent threat criteria (potential failure within five (5) days).

The Division of Flood Management, Flood Operations Branch in coordination with industry experts and specialized repair branches within DWR has developed an Engineer's Levee Threat Assessment (ELTA) that will be used to identify and collect information about levee threats. The ELTA will

standardize the information collected, define key decision criteria, and streamline the process of assessing the severity of the threat and urgency of the response. With ever increasing constraints on State budgets, more evidence is being required to authorize use of emergency authority and funding.

### 4.0 Non-Emergency Response

Threats that fall into the non-emergency response category are addressed through local repair efforts and a regional planning processes that identifies and prioritizes proposed flood system improvements. Financial assistance may be available through cost-share programs and grants. The FOC is not the point of contact for programmatic flood system improvements and financial assistance.

### Diagram

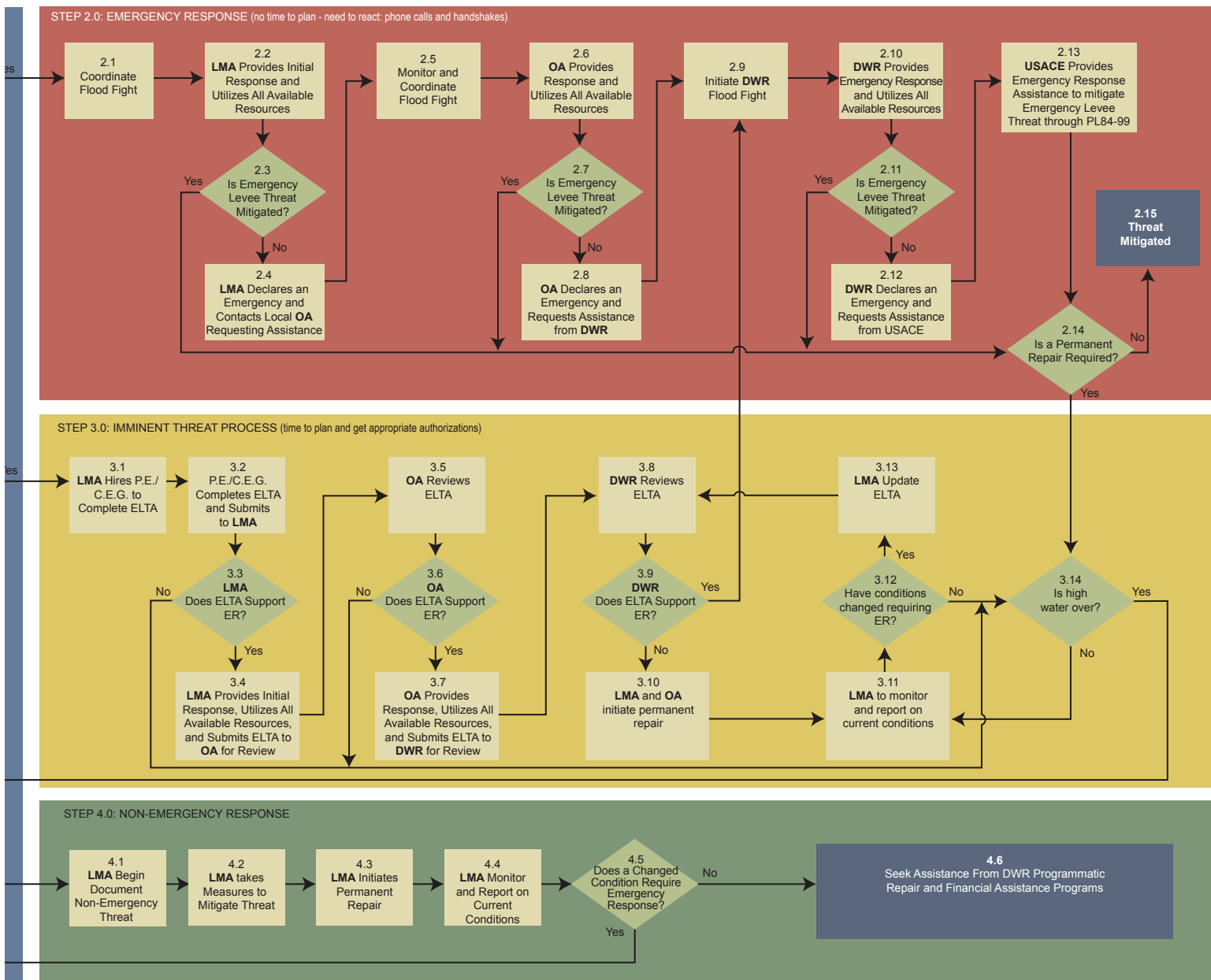

## Levee Threat Mitigation Process Workflow Diagram

# SUPPLEMENTAL DETAILS

### 1.0 Threat Identification and Initial Assessment

The purpose of this response level is to identify the potential levee threats and make an initial determination of the level of response (emergency, imminent threat, non-emergency). While DWR will continue to provide immediate support to emergency situations, some threats with longer lead times will require additional assessment for emergency response.

#### 1.1 Existing Threat

The existing threat may be identified by the Flood Project Integrity and Inspection Branch (FPIIB) during their annual inspections, the Urban Levee Evaluations Section (ULE), the Non-Urban Levee Evaluations Section (NULE), the Local Maintaining Agency (LMA) Annual Report, the Flood Maintenance Office (FMO), the Flood Projects Office (FPO), the Division of Engineering (DOE), the OA, the LMA, and other sources.

#### 1.2 New Threat

A new potential levee threat may be identified by the Local Maintaining Agency (LMA) during high water or by FPIIB.

#### 1.3 LMA Notifies Operational Area

The LMA shall notify its OA of the potential identified threat.

#### 1.4 LMA Notifies DWR

The LMA shall notify DWR about the potential identified threat and may request technical assistance.

#### 1.5 Flood Fight Specialist Conducts Site Visit

A DWR representative (Levee Inspector/Flood Fight Specialist/Geotechnical Specialist) may perform a site visit, document the levee stress, and recommend first response mitigation measures such as monitoring techniques or possible placement of sandbags or visquine plastic as specified in the Flood Fight Materials Field Guide.

#### 1.6 Does DWR Identify Threat as an Emergency?

An emergency is defined as failure expected within forty-eight (48) hours. The initial assessment by the DWR representative provides the information needed to assess the situation, and recommend a response. If DWR does identify the threat as an emergency, proceed to 2.1. If DWR does not identify the threat as an emergency, proceed to 1.7. If the situation needs further information to determine an appropriate response, the LMA may be requested to complete an Engineer's Levee Threat Assessment (see 3.1).



### 1.7 Is There High Potential for Failure in This Flood Season?

If the levee can contain water throughout the flood season, proceed to 1.8, levee threat is identified as a non-emergency. If the levee cannot contain water throughout the flood season and the failure leads to flooding, proceed to 3.1, Imminent Threat Process. An imminent threat is defined as potential system failure within five (5) days.

### 1.8 Levee Threat Identified as Non-Emergency

The levee threat is identified as a non-emergency, therefore proceed to 4.1, Non-Emergency Response.

## Threat Identification and Initial Assessment

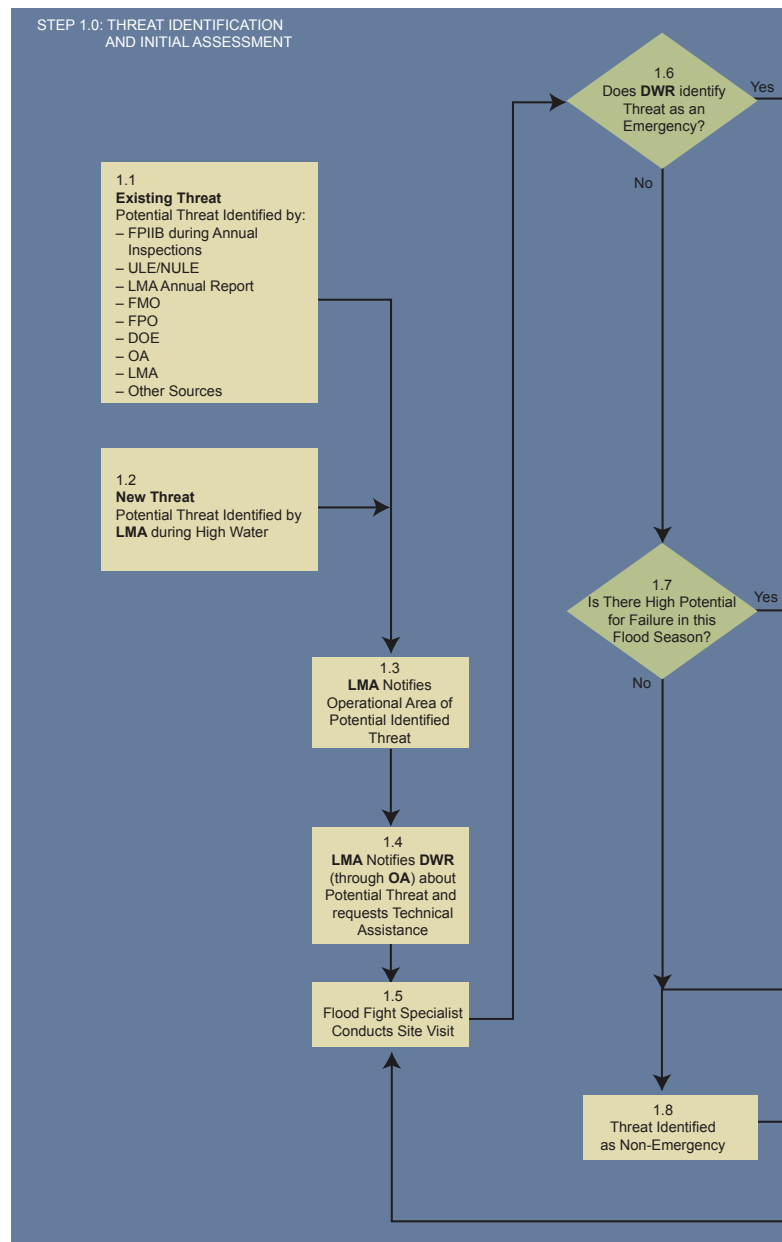

## 2.0 Emergency Response

The purpose of this response level is to make an immediate determination of the urgency of the threat. This is necessary to initiate the appropriate response which may include reassigning nearby resources from a lower response level. It is also necessary to prioritize the allocation of resources when there are multiple incidents occurring simultaneously. Emergency response can happen very quickly through communication techniques including phone calls and email. That being said, all documentation requirements must still be met, but may need to follow-up after the initial situation has been mitigated safely.

### 2.1 Coordinate Flood Fight

At the request of the local agency, a DWR Flood Fight Specialist can oversee activities and act as a technical resource for the levee threat and placement of materials.

### 2.2 LMA Provides Initial Response and Utilizes All Available Resources

LMA is responsible for all equipment and personnel required to mitigate the levee threat including all flood fight materials and manpower. The LMA shall utilize available resources to mitigate potential levee threat and initiate the incident documentation process to support FEMA cost recovery, including environmental assessment and timekeeping.

### 2.3 Emergency Levee Threat Mitigated?

If flood fight methods and materials have been sufficient to mitigate the levee threat, proceed to 2.14. If the emergency levee threat is not mitigated and all available resources have been utilized, proceed to 2.4.

### 2.4 LMA Declares Emergency and Requests Assistance from Operational Area

The LMA shall do the following:

- Propose a solution and submit a specific request to the OA for assistance (i.e. placement of specific materials over a specified distance).
- Identify and document the potential emergency levee threat
- Notify OA and FOC of potential levee threat (completed in 1.3 and 1.4)
- Identify available resources at its disposal that can be used to mitigate this threat (money, equipment, materials, manpower, volunteers, etc.)
- Identify potential environmental considerations for larger flood fight response
- Submit an approved resolution from its Board that declares an Emergency and specifies emergency funding limit associated with the Declaration
- Deliver that resolution to the OA Representative and cc: DWR
- Initiate LMA incident documentation process to support FEMA cost recovery

**During emergencies, the response requirements can be accomplished through phone calls, emails, or faxes, but will need to be followed up by more formal communications of key documentation such as declarations.**

### 2.5 Monitor and Coordinate Flood Fight

At the request of the OA and LMA, a DWR Flood Fight Specialist can oversee activities and act as a technical resource for the levee threat and placement of materials.

## Emergency Response

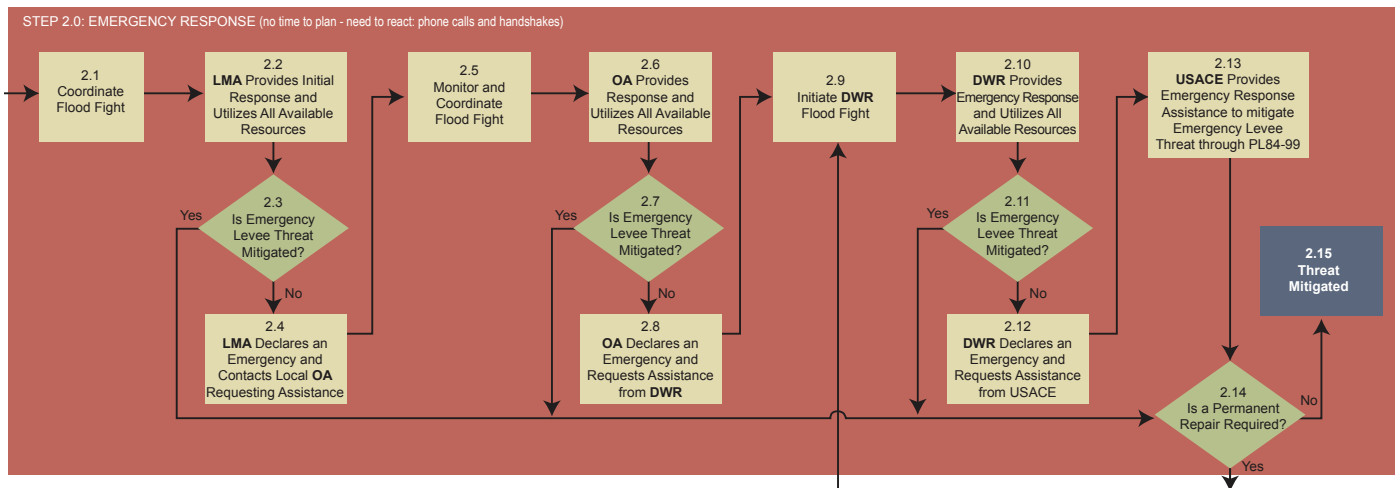

### 2.6 Operational Area Provides Response and Utilizes All Available Resources

OA and LMA are responsible for providing all equipment and personnel required to mitigate the levee threat including all flood fight materials and manpower. The OA shall utilize available resources to mitigate potential levee threat and initiate incident documentation process to support FEMA cost recovery, including environmental assessment and timekeeping.

The OA shall do the following:

- Assess the levee threat to determine additional emergency response actions and timing
- Notify people and property owners at risk from potential levee failure
- Determine state of emergency
- Determine evacuation level and issue initial evacuation orders as necessary
- Verify risk to lives and property including number of people, structures, infrastructure, businesses, livestock, and area of land impacted by a potential levee failure in this location
- Notify CalOES and FOC of potential levee threat
- Request technical assistance from CalOES and FOC
- Identify potential environmental considerations for larger flood fight response
- Identify and utilize available resources to mitigate this threat
- Initiate OA incident documentation process to support FEMA cost recovery, including environmental assessment and timekeeping





### 2.7 Emergency Levee Threat Mitigated?

If flood fight methods and materials have been sufficient to mitigate the levee threat, proceed to 2.14. If the emergency levee threat is not mitigated and all available resources have been utilized, proceed to 2.8.

### 2.8 Operational Area Declares Emergency and Requests Assistance from DWR

To receive assistance from DWR, the OA shall do the following:

- Propose a solution and submit a specific request to CalOES and DWR for assistance (i.e. manpower, equipment, or placement of specific materials over a specified distance)
- Identify what has been done to monitor and mitigate the levee threat
- Identify the available resources that can be used to mitigate this threat (money, equipment, materials, manpower, volunteers, etc.)
- Identify risk to lives and property including number of people, structures, infrastructure, businesses, livestock, and area of land impacted by a potential levee failure in this location
- Request flood fight assistance from CalOES and FOC.
- Submit an approved resolution from its Board of Supervisors that declares an Emergency and specifies emergency-funding limit associated with the Declaration
- Deliver resolution to DWR

**During emergencies, the response requirements can be accomplished through phone calls, emails, or faxes, but will need to be followed up by more formal communications of key documentation such as declarations.**

### 2.9 Initiate DWR Flood Fight

If all LTMP requirements have been met by the LMA and OA and an emergency threat has been determined, the information gathered in the previous sections will be used to support flood mobilization or activation. The FOC Director shall issue a Flood Alert Memorandum to authorize flood operations activities. After a Flood Alert Memorandum is issued, DWR shall activate its Flood Operations Center and organize into a SEMS/ICS Command Structure. A DWR Flood Fight Specialist can oversee activities and act as a technical resource for the levee threat and placement of materials.

## Emergency Response

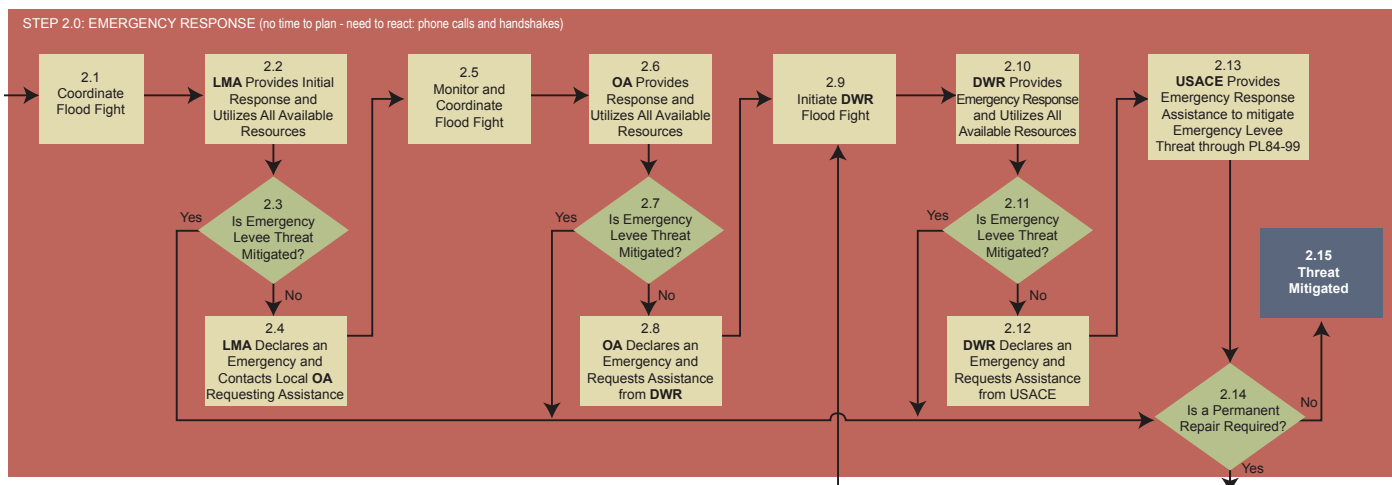

## 2.10 DWR Provides Response and Utilizes All Available Resources

DWR shall utilize all equipment, personnel (DWR, OA, LMA), and flood fight materials required to mitigate the levee threat. DWR shall exhaust available resources to mitigate potential levee threat.

The DWR shall do the following:

- Identify what has been done to monitor and mitigate the levee threat
- Assess the levee threat to determine additional emergency response actions and timing
- Identify the available resources that can be used to mitigate this threat
- Assess levee threat with flood fight specialist or geotechnical engineer to determine levee threat and response timing
- Alert DWR Executive, CalOES, and USACE executives of recommended emergency response
- Request Mission Tasking from CalOES for resources from other state agencies such as Caltrans, CCC, and/or CalFire
- Coordinate communications through LMA, OA, and DWR
- Submit a 10122 memorandum to DWR's Division of Engineering (DOE) to justify emergency response
- Task DOE to begin the emergency contracting and procurement process
- Initiate DWR incident documentation process to support FEMA cost recovery, including environmental assessment and timekeeping

## 2.11 Emergency Levee Threat Mitigated?

If flood fight methods and materials have been sufficient to mitigate the levee threat, proceed to 2.14. If the emergency levee threat is not mitigated and all available resources have been utilized, proceed to 2.12.

## 2.12 DWR Declares Emergency and Requests USACE Assistance

DWR may request assistance from the U.S. Army Corps of Engineers (USACE) through PL 84-99. A formal assistance request letter addressed to the USACE District Commander is required.

## 2.13 USACE Provides Emergency Response through PL 84-99

USACE shall provide emergency response by using available resources until emergency levee threat is mitigated as requested in PL 84-99 request

## 2.14 Is a Permanent Repair Required?

If a permanent repair is required, proceed to 1.8; the threat is now considered a non-emergency and will now step through the non-emergency response. If a permanent repair is not required, proceed to 2.15.

## 2.15 Threat Mitigated

The emergency levee threat is mitigated and no permanent repair is required. Confirm that this site is identified in the local Emergency Action Plan as a potential threat location so it can be monitored closely during the next high water event.

### 3.0 Imminent Threat Process

During the Imminent Threat Process, the levee threat has been determined to not immediately require an emergency response (potential failure within forty-eight (48) hours). The purpose of Imminent Threat Process is to develop additional information about the threat in order to determine that it meets imminent threat criteria (potential failure within five (5) days).

The Division of Flood Management, Flood Operations Branch in coordination with industry experts and specialized repair branches within DWR has developed an Engineer's Levee Threat Assessment (ELTA) that is used to identify and collect information about levee threats. The ELTA standardizes the information collected, defines key decision criteria, and streamlines the process of assessing the severity of the threat and urgency of the response. With ever increasing constraints on State budgets, more evidence is being required to authorize use of emergency authority and funding.

**If this levee threat is predicted to cause catastrophic failure within forty-eight (48) hours, DO NOT complete the ELTA. Contact the Operational Area and Flood Operations Center at (916) 574-2619.**

#### 3.1 LMA Hires P.E./C.E.G. to Complete ELTA

The LMA shall have a California licensed Professional Engineer or a Certified Engineering Geologist to complete and stamp the ELTA.

#### 3.2 P.E./C.E.G. Completes ELTA and Submits to LMA

The Professional Engineer or Certified Engineering Geologist shall complete and stamp the ELTA within 24 hours of being hired by the LMA. Not all of the information on the ELTA is required, but adequate information should be provided to justify further actions. After completing the ELTA, the P.E./C.E.G. shall submit it to the LMA for review.

#### 3.3 LMA: Does ELTA Support ER?

The LMA shall decide if the ELTA supports an emergency response based on the information contained within and supplemental site visits conducted by the LMA. If the ELTA does not support emergency response, proceed to 3.14.

#### 3.4 LMA Provides Initial Response, Utilizes All Available Resources, and Submits ELTA to OA for Review

The LMA shall provide the initial response to the incident and utilize all available resources in order to mitigate the levee threat. This includes all sand, sandbags, heavy equipment, personnel, etc. While the LMA is providing the initial response, they shall submit the completed ELTA to the OA for review.

#### 3.5 OA Reviews ELTA

The Operational Area shall review the ELTA.

#### 3.6 OA: Does ELTA Support ER?

The OA shall decide if the ELTA supports an emergency response based on the information contained within and supplemental site visits conducted by the LMA and OA. If the ELTA does not support emergency response, proceed to 3.14.

#### 3.7 OA Provides Response, Utilizes All Available Resources, and Submits ELTA to DWR for Review

The OA shall provide additional response to the incident and utilize all available resources in order to mitigate the levee threat. This includes all sand, sandbags, heavy equipment, personnel, etc. While the OA is providing the additional response, they shall submit the completed ELTA to the DWR for review.

### Imminent Threat Process

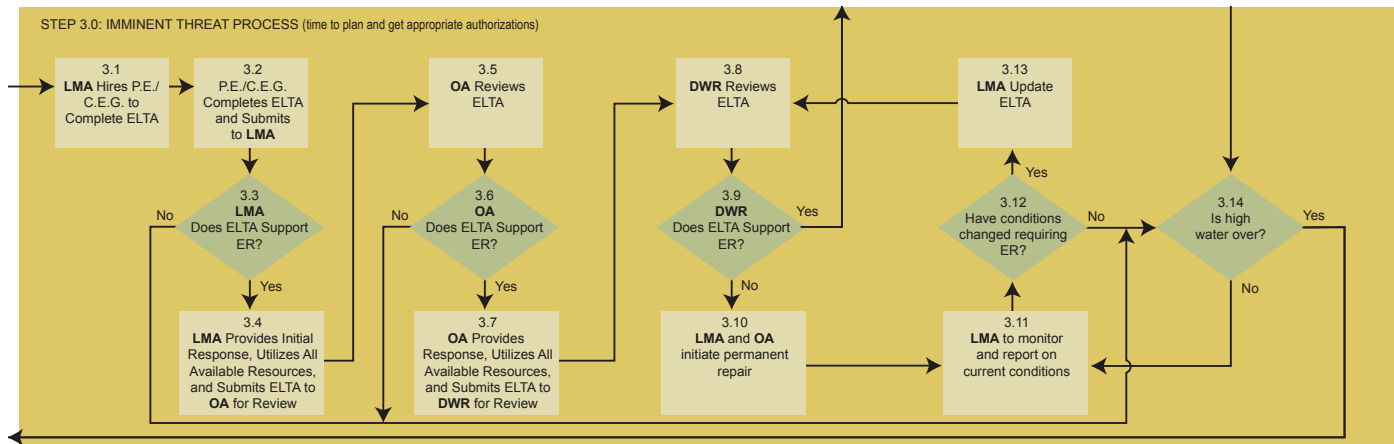

### 3.8 DWR Reviews ELTA

The State-Federal Flood Operations Center within the Department of Water Resources shall review the ELTA.

### 3.9 DWR: Does ELTA Support ER?

DWR shall decide if the ELTA supports an emergency response based on the information contained within and supplemental site visits conducted by the LMA, OA, and DWR. If the ELTA does not support emergency response, proceed to 3.14.

### 3.10 LMA and OA Initiate Permanent Repair Process

The LMA and OA shall secure the proper permits and begin the process to complete a permanent repair.

### 3.11 LMA to Monitor and Report on Current Conditions

LMA shall send addendums to the ELTA as conditions change. The Levee Threat Monitoring Guidelines (LTMG) can be used as a guide to indicate the information that can be included in levee patrol logs or reports that show the nature of the changing conditions.

### 3.12 DWR: Have Conditions Changed Requiring ER?

DWR will continue to monitor weather and hydrology conditions and review status updates from the LMA regarding the levee threat. If conditions change and criteria for imminent threat are met, the LMA shall update the ELTA per step 3.13.

### 3.13 LMA Update ELTA

If conditions have changed requiring emergency response, the LMA shall have their P.E./C.E.G. update the ELTA incorporating all new information. The LMA shall complete and stamp the ELTA within 24 hours of being hired by the LMA. Not all of the information on the ELTA is required, but adequate information should be provided to justify further actions. After completing the ELTA, the P.E./C.E.G. shall resubmit it to the LMA and DWR for review.

### 3.14 Is High Water Over?

Without high water posing a threat, a failure cannot result in flooding and a permanent repair should be initiated.

## 4.0 Non-Emergency Response

Threats that fall into the non-emergency response category are addressed through local repair efforts and a regional planning processes that identifies and prioritizes proposed flood system improvements. Financial assistance may be available through cost-share programs and grants. The FOC is not the point of contact for programmatic flood system improvements and financial assistance.

### 4.1 LMA Document Threat to Support Cost Recovery

The LMA and OA shall keep track of personnel hours, contractor costs, material costs, and complete an environmental baseline assessment (including pictures) based on current conditions and potential mitigation measures.

### 4.2 LMA and OA Takes Measures to Mitigate Threat

The LMA and OA shall make plans to mitigate the levee threat including Emergency Response (ER) action plans (if conditions change to a full ER) and shall identify mitigation method, equipment, materials, staging areas, traveling routes, schedule, cost estimate, contractor bids, etc.

### 4.3 LMA Initiates Permanent Repair

The LMA shall secure the proper permits and begin the process to complete a permanent repair.

### 4.4 LMA Monitors and Reports on Current Conditions

LMA shall send addendums to the ELTA as conditions change. The Levee Threat Monitoring Guidelines (LTMG) can be used as a guide to indicate the information that can be included in levee patrol logs or reports that show the nature of the changing conditions.

### 4.5 Does a Changed Condition Require Emergency Response?

The LMA shall specify what has changed and how this change affects the levee status and emergency response.



## Non-Emergency Response

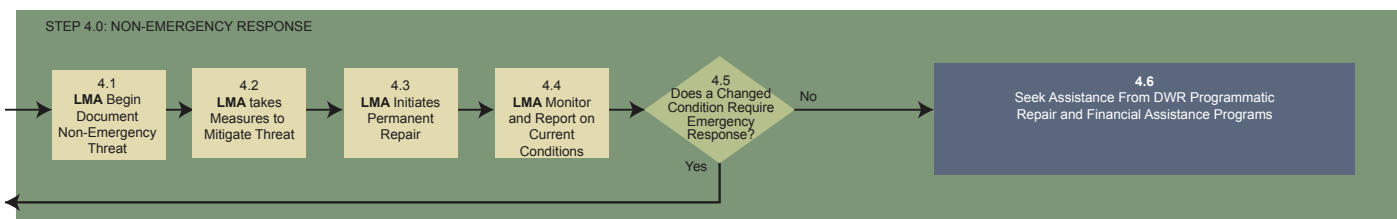

#### 4.6 Seek Assistance from DWR Programmatic Repair and Financial Assistance Programs

Local Maintaining Agencies are responsible for the operations and maintenance of flood control facilities including repair of damages or deficiencies to ensure the facilities can provide their designed capacities. Critical repairs should be dealt with as soon as possible.

DWR has programs to provide financial support for facility repairs. In order to be eligible to receive financial assistance for repairs, local agencies must satisfy prerequisites which include:

- Routine reporting on the condition of their facilities based upon inspections and analyses using standard method acceptable to DWR
- Routing training program which includes flood fight methods and NIMS/SEMS compliant training
- Documentation of operation and maintenance program and plan for facility improvements that reduce residual risk
- Up-to-date Emergency Action Plans that include:
  - » Contact call list with current phone numbers
  - » List of available equipment, location details, and access protocol
  - » List of flood fight materials, location details, and access protocols
  - » Levee Patrol Plan
  - » Volunteer list with contact information
  - » Flood fight plan describing procedures used when an issue or threat is found
  - » Environmental Plan and documentation procedure
  - » List of the critical assets located in the area protected by the levees, which may include, but are not limited to: water treatment plants, wastewater treatment plants, power plants, schools, hospitals, emergency service facilities, hazardous materials facilities, etc.
  - » Evacuation plans and evacuation routes
  - » Location of Emergency Operation Center (EOC)
  - » List of vulnerabilities and critical repair sites

The following pages contain the name and contact information for some of the programs that provide financial assistance. The Flood System Repair Program is being developed to help address the most critical facility repairs.

#### Flood System Repair Program

DWR is proposing the **Flood System Repair Program (FSRP)** to proactively assist public agencies responsible for maintaining facilities of the State Plan of Flood Control (SPFC). The FSRP is being funded from a portion of funding authorized for the evaluation, repair, rehabilitation, reconstruction, or replacement of levees, weirs, bypasses, and facilities of the SPFC under Section 5096.821 of the Public Resources Code.

The objectives of the FSRP are as follows:

- Repair critical and serious damage to SPFC facilities in partnership with the LMAs.
- Assist LMAs to proactively repair damage that is within the overall scale of the LMAs maintenance program and can reasonably be performed by the LMA, but which fall outside of activities that are considered to be routine maintenance.

The FSRP is applicable to projects involving repair of damaged facilities of the SPFC maintained by LMAs or by DWR, which may include levees, channels, and related flood control features.

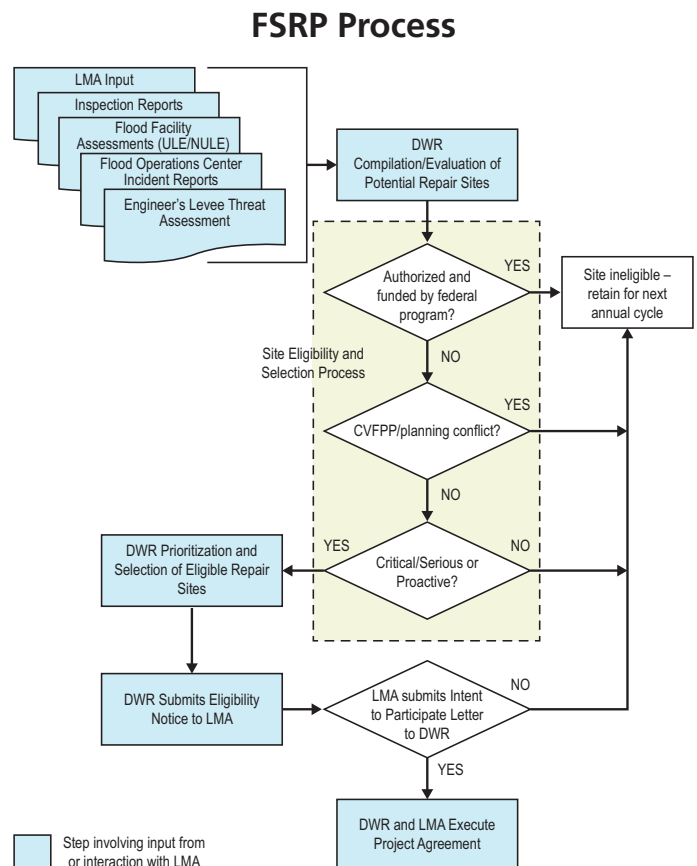

## Financial Assistance Programs

Potential financial assistance programs for repairs include:

### Delta Levees Special Flood Control Projects

**Purpose:** The Delta Levees Special Flood Control Projects provides financial assistance to local levee maintaining agencies for rehabilitation of levees in the Delta.

**Website Address:** [http://www.water.ca.gov/floodsafe/fessro/levees/special\\_projects](http://www.water.ca.gov/floodsafe/fessro/levees/special_projects)

**Funding:** Since the inception of the program, more than \$100 million have been provided to local agencies in the Delta for flood control and related habitat projects.

### Delta Levees Maintenance Subventions

**Purpose:** The Delta Levees Maintenance Subventions Program is a cost share program that provides technical and financial assistance to local levee maintaining agencies in the Sacramento - San Joaquin Delta for the maintenance and rehabilitation of non-project and eligible project levees.

**Website Address:** <http://www.water.ca.gov/floodsafe/fessro/levees/subventions>

**Funding:** \$54 million

### Flood Emergency Response Financial Assistance Program- Sacramento San Joaquin River Delta

**Purpose:** To improve local flood emergency response through development of the local and regional flood emergency response plan, improving communication among emergency response entities at local, state and federal levels, and effectively prepare and respond to flood emergencies. DWR will release final guidelines in 2012 for the Flood Emergency Response Projects-Delta.

**Website:** <http://www.water.ca.gov/floodmgmt/hafoo/fob/floodER/>

**Funding:** \$5 million Proposition 1E funding will be available for this grant program

### Flood Emergency Response Financial Assistance Program- Statewide

**Purpose:** To improve local flood emergency response through development of the local and regional flood emergency response plan, improving communication among emergency response entities at local, state and federal levels, and effectively prepare and respond to flood emergencies. DWR will release final guidelines in 2012 for the Flood Emergency Response Projects-Statewide.

**Website:** <http://www.water.ca.gov/floodmgmt/hafoo/fob/floodER/>

**Funding:** \$5 million Proposition 84 funding will be available for this grant program

### Flood System Repair Program

**Purpose:** This program will provide financial assistance to local agencies to repair critical deficiencies within the State Plan of Flood Control levees.

**Website:** <http://www.water.ca.gov/floodmgmt/fmo/fsrp>

**Funding:** Up to \$130 million of proposition 1E funding will be available for this program

### Flood Control Subventions Program

**Purpose:** The Flood Control Subventions program (FCSP) provides financial assistance to non-federal sponsors cooperating in the construction of federally authorized flood control projects.

**Website Address:** <http://www.water.ca.gov/floodmgmt/fpo/sgb/fcs/>

**Funding:** California Water Code provides authorization for each flood control project and specifies the maximum State cost share (50%-70%) for costs associated with the project lands, easements, relocations, right-of-way, and disposal sites (LERRDS)

### Flood Protection Corridor Program

**Purpose:** Financial assistance for flood risk reduction projects statewide, integrated with habitat conservation and restoration and/or agricultural land protection.

**Website Address:** <http://www.grantsloans.water.ca.gov/grants/corridor.cfm>

**Funding:** \$70 million Prop. 13, \$40 million Prop. 84. \$5 million per eligible project

### Local Levee Assistance Program

**Purpose:** Provides Proposition 84 financial assistance statewide for the evaluation, repair, and improvement of flood control structures. Eligible projects include facilities that are not part of the State Plan of Flood Control and are not located within the Sacramento-San Joaquin Delta. Facilities located in the Central Valley are eligible if they are non-project levees and do not protect urban areas.

**Website Address:** <http://www.water.ca.gov/floodmgmt/fpo/sgb/llap/>

**Funding:** \$13 million

### IRWM Implementation Grants

**Purpose:** Financial assistance available to implement projects and programs that are consistent with IRWM plans and provide multiple benefits.

**Website Address:** <http://www.water.ca.gov/irwm/grants/implementation.cfm>

**Funding:** \$808.5 million

### IRWM Stormwater Flood Management Grants

**Purpose:** Financial assistance for projects that manage stormwater runoff to reduce flood damage and provide and other benefits and are consistent with and IRWM plan.

**Website Address:** <http://www.water.ca.gov/irwm/grants/stormwaterflood.cfm>

**Funding:** \$300 million



**Edmund G. Brown Jr.**  
Governor  
State of California

**John Laird**  
Secretary  
California Natural Resources Agency

**Mark Cowin**  
Director  
Department of Water Resources

**For additional information, contact:**

Darren Suen, Flood Operations Center Chief  
(916) 574-1358  
darren.suen@water.ca.gov

Or visit us on the Web at [www.water.ca.gov](http://www.water.ca.gov)

The following publications aid in emergency preparedness and response and all are available upon request.

Please contact the Flood Operations Center at (916) 574-2619 or [flood\\_center@water.ca.gov](mailto:flood_center@water.ca.gov) to request copies.

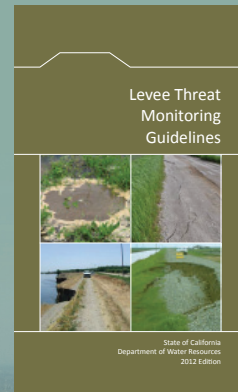
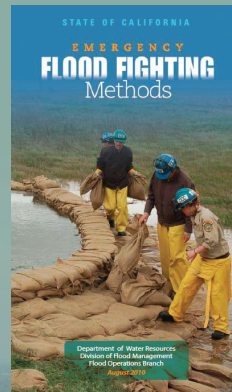
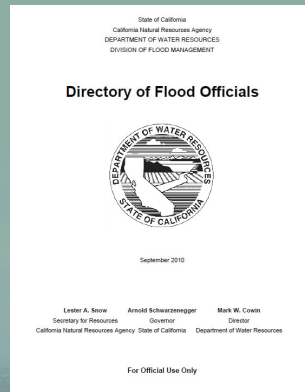
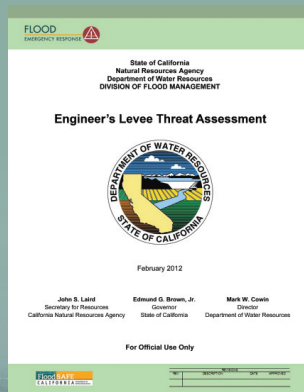

**For all flood emergencies, questions, or for additional information, please contact:**  
**State-Federal Flood Operations Center**  
**(916) 574-2619 (800) 952-5530**  
**[flood\\_center@water.ca.gov](mailto:flood_center@water.ca.gov)**

Prepared by GEI Consultants, Inc. for The California Department of Water Resources  
Naser Bateni, Program Manager (PE 36128)



PUBLIC SAFETY

ENVIRONMENTAL STEWARDSHIP

ECONOMIC STABILITY



**Appendix P**

**San Joaquin County Office of Emergency Services Hazardous Materials  
Area Plan**

**SAN JOAQUIN COUNTY**  
**OFFICE OF EMERGENCY SERVICES**



**HAZARDOUS MATERIALS**  
**AREA PLAN**

November 2008

TABLE OF CONTENTS

SECTION	PAGE
<b>SECTION 1: PROPOSED AREA PLAN .....</b>	<b>1-1</b>
1.1 GENERAL .....	1-1
1.2 OBJECTIVES .....	1-1
1.3 PREVENTION AND MITIGATION ACTIVATION .....	1-2
1.4 PLAN AND APPROVAL AND EXISTING FORMAL AGREEMENT .....	1-3
1.5 AREA PLAN UPDATE AND IMPLEMENTATION (§2721 AREA PLAN MAINTENANCE) .....	1-3
1.6 AREA PLANS RELATIONSHIP TO OTHER PLANS .....	1-3
1.7 BUSINESS PLAN INFORMATION .....	1-3
1.7.1 <i>Integrating Business Information into Area Plan</i> .....	1-4
1.8 ENSURING BUSINESS PLAN ACCURACY AND PRE-INCIDENT SURVEYS .....	1-4
1.8.1 <i>Fire Department Access to Program Data</i> .....	1-4
1.9 RMP - ACUTELY HAZARDOUS MATERIALS .....	1-4
1.10 AREA PLAN CHECKLIST .....	1-5
<b>SECTION 2: PROCEDURES AND PROTOCOL .....</b>	<b>2-6</b>
<b>FOR EMERGENCY RESPONSE PERSONNEL .....</b>	<b>2-6</b>
2.1 REFERENCES TO FOLLOW DURING INCIDENTS .....	2-6
2.1.1 <i>Emergency Operations Plans</i> .....	2-6
2.1.2 <i>Joint Team, State of California, and Federal Procedures</i> .....	2-6
2.1.3 <i>Communications Centers</i> .....	2-6
2.2 APPROACH, RECOGNITION, AND EVALUATION OF INCIDENTS .....	2-7
2.2.1 <i>Approach and Evaluation</i> .....	2-7
2.3 IDENTIFYING POTENTIAL RELEASE IMPACTS .....	2-7
2.4 PERSONAL PROTECTIVE EQUIPMENT AND EMERGENCY EQUIPMENT GUIDELINES .....	2-7
2.5 MONITORING AND DECONTAMINATION GUIDELINES .....	2-7
<b>SECTION 3: PRE-EMERGENCY PLANNING .....</b>	<b>3-9</b>
3.1 GENERAL .....	3-9
3.2 PRE-EMERGENCY PLANNING AND COORDINATION .....	3-9
3.3 INDUSTRY COORDINATION .....	3-9
3.4 COORDINATION BETWEEN AGENCIES .....	3-9
3.4.1 <i>San Joaquin Operational Area Council</i> .....	3-9
3.4.2 <i>Fire Chiefs' Association Special Operations Committee</i> .....	3-10
3.4.3 <i>San Joaquin County Toxic Enforcement Strike Force</i> .....	3-10
3.4.4 <i>Joint Team Steering Committee</i> .....	3-10
3.4.5 <i>Weapons of Mass Destruction Steering Committee</i> .....	3-10
3.4.6 <i>County Public Health and Pesticide Drift Protocols</i> .....	3-10
3.4.7 <i>State and Federal Coordination</i> .....	3-10
3.5 MUTUAL AID AGREEMENTS .....	3-11
3.5.1 <i>California Master Mutual Aid Agreement</i> .....	3-11
3.5.2 <i>San Joaquin County Fire Service Mutual Aid Agreement</i> .....	3-11
3.5.3 <i>Joint Hazardous Materials Technician/Specialist Mutual Aid</i> .....	3-11
3.5.4 <i>Out of County Agreements</i> .....	3-11
3.5.5 <i>Private Business or Facilities Agreements</i> .....	3-11
3.6 ACTIVATION/DEACTIVATION OF EMERGENCY RESPONSE AGENCIES .....	3-12
3.7 ACCESS TO FUNDING .....	3-12
3.7.1 <i>Reimbursement/Cost Recovery Options</i> .....	3-12
3.7.2 <i>Cost Recovery From Responsible Parties</i> .....	3-12

3.8	ACCESS TO DISPOSAL FACILITIES AND CONTRACTORS.....	3-13
3.8.1	<i>Available Disposal Sites</i> .....	3-13
3.9	STATE AUTHORITY TO APPROVING FUNDING .....	3-13
3.10	INCIDENT MANAGEMENT ORGANIZATION .....	3-13
3.11	AGENCY FUNCTIONAL RESPONSIBILITY MATRIX (ATTACHMENT 3) .....	3-14
3.12	PHASES OF INCIDENT .....	3-14
3.12.1	<i>Initial Response Phase</i> .....	3-14
3.12.2	<i>Criteria for change in Phase</i> .....	3-14
3.12.3	<i>Control and Stabilization Phase</i> .....	3-15
3.13	COMMAND STRUCTURE AND RESPONSIBILITIES .....	3-15
3.13.1	<i>Incident Command</i> .....	3-15
3.13.2	<i>Transfer of Incident Command</i> .....	3-15
3.14	CONTROL AND STABILIZATION PHASE.....	3-16
3.14.1	<i>Private Sector Role</i> .....	3-16
3.15	RESPONSE TERMINATION PHASE .....	3-16
<b>SECTION 4: NOTIFICATION AND COORDINATION .....</b>		<b>4-17</b>
4.1	COMMUNICATIONS PLANNING AGENCIES .....	4-17
4.1.1	<i>Communications Planning Meetings</i> .....	4-17
4.2	NOTIFICATION PROCEDURES.....	4-17
4.2.1	<i>Notification Telephone Numbers</i> .....	4-18
4.3	COMMUNICATIONS PLAN .....	4-18
4.3.1	<i>Radio Frequencies</i> .....	4-19
4.3.2	<i>Alternate Means of Communications</i> .....	4-19
4.4	RESPONSE AGENCY COORDINATION ROLES .....	4-19
4.4.1	<i>Local Agency Response</i> .....	4-19
4.4.2	<i>Operational Area</i> .....	4-20
4.4.3	<i>Local Emergency Proclamations and Declarations</i> .....	4-20
4.4.4	<i>Regional and Statewide Response</i> .....	4-21
4.4.5	<i>Federal Agency Response</i> .....	4-21
4.5	CALIFORNIA HAZARDOUS MATERIALS INCIDENT REPORT SYSTEM (CHMIRS).....	4-21
<b>SECTION 5: TRAINING .....</b>		<b>5-23</b>
5.1	BUSINESS TRAINING .....	5-23
5.2	FIRST RESPONDER.....	5-23
5.3	JOINT HAZARDOUS MATERIALS STEERING COMMITTEE.....	5-23
5.3.1	<i>Standardized Emergency Management System (SEMS) and National Incident Management System (NIMS)</i> 5-24	
5.3.2	<i>Hazardous Materials Response Training:</i> .....	5-24
5.3.3	<i>Hazardous Waste Site Emergency Response:</i> .....	5-24
5.4	INCIDENT DRILLS AND EXERCISES .....	5-24
5.4.1	<i>Table Top Exercises</i> .....	5-24
5.4.2	<i>Hospital Drills</i> .....	5-25
5.4.3	<i>Facility Drills</i> .....	5-25
5.4.4	<i>Planning and Scheduling Drills</i> .....	5-25
5.4.5	<i>Functional Exercises</i> .....	5-26
<b>SECTION 6: PUBLIC SAFETY AND INFORMATION .....</b>		<b>6-27</b>
6.1	SITE PERIMETER SECURITY .....	6-27
6.2	RESPONSIBILITY FOR INFORMING BUSINESSES AND PUBLIC .....	6-27
6.2.1	<i>Emergency Alert System. Procedures for Notifying Businesses and Public</i> .....	6-27
6.2.2	<i>Generic EAS Message Format</i> .....	6-27
6.3	NOTIFICATION SYSTEMS .....	6-28
6.3.1	<i>Radio Communications Plan</i> .....	6-28
6.3.2	<i>Emergency Alert System (EAS)</i> .....	6-28

6.3.3	<i>Emergency Digital Information System (EDIS)</i> .....	6-28
6.3.4	<i>City Watch</i> .....	6-28
6.3.5	<i>Radio Amateur Emergency Services (RACES)</i> .....	6-28
6.3.6	<i>Emergency Advisory Radio Systems (EARS) and Radio Lodi</i> .....	6-29
6.3.7	<i>Telephone Emergency Notification System (TENS)</i> .....	6-29
6.3.8	<i>Office of Emergency Services Website</i> .....	6-29
6.4	NOTIFICATION PROCEDURES .....	6-29
6.4.1	<i>Central Information Clearing House</i> .....	6-30
6.4.2	<i>Timely Notification</i> .....	6-30
6.5	EVACUATIONS AND SHELTER-IN-PLACE ACTIONS .....	6-31
6.5.1	<i>Centralized Coordination of Agency Information</i> .....	6-31
6.5.2	<i>Coordination Checklist</i> .....	6-32
6.6	SHARING POTENTIAL HAZARDS AND HAZARDOUS MATERIALS PROPERTIES .....	6-32
6.6.1	<i>Information on Pesticides</i> .....	6-32
6.6.2	<i>Informing the Public of HAZMAT Properties</i> .....	6-33
6.6.3	<i>Release Scenarios</i> .....	6-33
6.6.4	<i>Preplanning Properties for Protective Actions</i> .....	6-33
6.6.5	<i>Safe Route of Approach</i> .....	6-34
6.7	MEDICAL RESOURCES .....	6-34
6.8	MASS CARE SHELTER .....	6-34
6.8.1	<i>Shelter Operations Agency</i> .....	6-34
6.8.2	<i>Local Shelter Non-Profit Agencies</i> .....	6-35
6.8.3	<i>Animal Sheltering</i> .....	6-35
6.8.4	<i>Disaster Welfare Inquiries</i> .....	6-35
6.9	INCIDENT RECOVERY OPERATIONS .....	6-35
6.9.1	<i>Disaster Recovery Plan</i> .....	6-36
<b>SECTION 7: SUPPLIES AND EQUIPMENT .....</b>		<b>7-37</b>
7.1	AGENCY RESPONDERS .....	7-37
7.1.1	<i>Fire and Medical</i> .....	7-37
7.1.2	<i>Hazardous Materials Teams</i> .....	7-37
7.1.3	<i>Public Works/Municipal Utilities</i> .....	7-38
7.1.4	<i>Local Public Health Agencies and County Agricultural Commissioner’s Office</i> .....	7-38
7.1.5	<i>Law Enforcement Agencies</i> .....	7-38
7.2	EMERGENCY OPERATIONS CENTER (EOC) .....	7-38
7.2.1	<i>City Emergency Operations Centers</i> .....	7-39
7.2.2	<i>Access to Equipment</i> .....	7-39
7.3	EMERGENCY RESPONSE CAPABILITIES .....	7-39
7.3.1	<i>Mobilization Centers</i> .....	7-39
7.3.2	<i>Staging Areas</i> .....	7-39
7.3.3	<i>Rendezvous Points</i> .....	7-40
7.3.4	<i>Casualty Collection Points/Field Treatment Sites</i> .....	7-40
7.4	SAN JOAQUIN COUNTY EMERGENCY RESOURCES .....	7-40
7.4.1	<i>Private Sector</i> .....	7-40
7.4.2	<i>Public Sector</i> .....	7-40
<b>SECTION 8: INCIDENT CRITIQUE AND FOLLOW-UP.....</b>		<b>8-42</b>
8.1	POST INCIDENT ANALYSIS FOR ROUTINE INCIDENTS IN THE SAN JOAQUIN OPERATIONAL AREA .....	8-42
8.2	COMMUNITY CRITIQUES .....	8-42
<b>SECTION 9: SECTION 25503 (E) INFORMATION .....</b>		<b>9-43</b>
9.1	BUSINESS HAZARDOUS MATERIALS DISCLOSURE INFORMATION .....	9-43
9.2	DATA MANAGEMENT SYSTEM .....	9-43
<b>SECTION 10: LOCAL RESOURCE INFORMATION .....</b>		<b>10-44</b>

10.1	IDENTIFICATION OF NATURAL RESOURCES AND LOCAL CONDITIONS .....	10-44
10.1.1	<i>Significant Natural Resource Areas</i> .....	10-44
10.1.2	<i>Structures Located in Marine Waters</i> .....	10-44
10.1.3	<i>Areas Where Spills are Most Likely to Occur</i> .....	10-45
10.2	IDENTIFICATION OF FACILITIES AND LOCAL AREAS OF CONCERN TO LOCAL GOVERNMENT .....	10-45
10.2.1	<i>Facility Prioritization</i> .....	10-45
10.2.2	<i>Economic Resources Prioritization</i> .....	10-45
10.2.3	<i>Significant Areas Requiring Closure or Protective Measures</i> .....	10-45
<b>SECTION 11: ATTACHMENTS .....</b>		<b>11-50</b>
11.1	ORGANIZATIONAL CHARTS .....	11-50
11.2	INCIDENT COMMAND AUTHORITY .....	11-50
11.3	JURISDICTIONAL/AGENCY ROLES AND RESPONSIBILITIES .....	11-50
11.4	USCG-EPA BOUNDARY MAP .....	11-50
11.5	TRAINING TABLE .....	11-50
11.6	HEALTH OFFICER AUTHORITY .....	11-50
11.7	VACANT .....	11-50
11.8	VACANT .....	11-50
11.9	VACANT .....	11-50
11.10	NOTIFICATION PROCEDURES.....	11-50
11.11	VACANT .....	11-50
11.12	RADIO SYSTEMS.....	11-50
<b>SECTION 12: APPENDIX.....</b>		<b>12-51</b>
12.1	VACANT .....	12-51
12.2	VACANT .....	12-51
12.3	RESPONSE LEVELS .....	12-51
12.4	POSITION CHECKLISTS .....	12-51
12.5	RESPONSE POLICIES .....	12-51
12.6	CLEAN UP POLICIES .....	12-51
12.7	VACANT .....	12-51
12.8	VACANT .....	12-51
12.9	HOSPITAL HAZARDOUS MATERIALS GUIDELINES.....	12-51
12.10	DEPLOYMENT OF MASS DECONTAMINATION SYSTEMS .....	12-51
12.11	OIL SPILL PROCEDURES SAN JOAQUIN.....	12-51
12.12	JOINT HAZARDOUS MATERIALS RESPONSE TEAM - POLICIES AND PROCEDURE.....	12-51

## SECTION 1: PROPOSED AREA PLAN (§2720 H&S)

### 1.1 General

This document describing the San Joaquin County Hazardous Materials Emergency Response System is prepared according to statutory requirements.<sup>1/</sup> The County's several jurisdictions have specific procedures and authorities for hazardous materials response in their individual operational plans. This summary does not supersede those plans or policies but instead summarizes the common ideas and capabilities contained in the individual operational plans.

San Joaquin County organizes and structures hazardous material emergency response according to FIRESCOPE and SEMS guidance.<sup>2/</sup> Section 4 of this document describes how the FIRESCOPE system is applied through notification and coordination and adapted to hazardous materials incidents within the San Joaquin County response jurisdiction.

This 2008 update goes into further detail on Standardized Emergency Management (SEMS) and National Incident Management (NIMS) systems and integration with agencies participating with the plan. In addition, the plan now covers procedures for response to Pesticide Drift incidents as required by State Bill 391 (Florez).<sup>3</sup>

### 1.2 Objectives

Administrative Objective: To meet minimum State statutory requirements for the development of area plans.<sup>4/</sup> This includes describing the County hazardous materials response system and those procedures and capabilities common to all jurisdictions.

Operational Objectives: The overall goal of the hazardous materials response system developed by the jurisdictions of San Joaquin County is to protect public health, prevent environmental damage, and ensure proper use and disposal of hazardous materials. This response system has three operational objectives:

---

<sup>1</sup> §25500, Article 1, Chapter 6.95, Division 20, Health and Safety Code; §852.62.2, Article 2, Chapter 5, Subdivision 4, Division 1, Title 14, Code of Regulations

<sup>2</sup> §8608, Article 9.7, Chapter 7, Division 1, Title 2, Government Code; Incident Command System (ICS) Module HM120 - **Firefighting RESources of California Organized For Potential Emergencies**

<sup>3</sup> Not as yet codified. Pesticide Drift Exposure Response Act (SB-391-Florez)

<sup>4</sup> §25500, Article 1, Chapter 6.95, Division 20, Health and Safety Code



1. Maintain effective response capabilities to contain and control releases and mitigate their impact on the public and environment.
2. Maintain the capability to oversee long-term cleanup and mitigation of residual release effects on public health and the environment.
3. Ensure that the efforts of all jurisdictions and agencies are effectively integrated.

Prevention Objective: A primary objective is the prevention of incidents in the first place. County prevention activities include a combination of inspections and regulatory oversight, training courses, and enforcement actions. A primary tool for accomplishing prevention is enforcement of State and Federal statutory requirements.<sup>5/</sup>

### 1.3 Prevention and Mitigation Activation

The local Administering Agency for the Hazardous Materials Management Plan Program is the San Joaquin County Office of Emergency Services (OES). The Office of Emergency Services is a Participating Agency under the County Certified Unified Program Agency. Under this program, businesses must prepare emergency plans for hazardous materials incidents, train employees, and make proper notifications during incidents. Administering Agency staff reviews plans, training documents, and general safety conditions during routine inspections.

Other agencies and jurisdictions within the County also provide prevention activities including:

- Fire departments and/or Fire Warden (Fire Code)
- Regional Air Pollution District (Air Pollution Regulatory Programs)
- Environmental Health Division (Underground Tank and Waste Handler Programs)
- Agricultural Commissioner (Agricultural Chemical Use and Pesticide Drift Programs)
- Community Development Department (Building Codes and Planning Code Ordinances)
- District Attorneys Office (Toxic Enforcement Strike Force)
- Public Works (Household Hazardous Waste Program)

---

<sup>5</sup> §25500, Article 1, Chapter 6.95, Division 20, Health and Safety Code  
San Joaquin Operational Area  
– Hazardous Materials Area Plan

#### **1.4 Plan and Approval and Existing Formal Agreement**

Formal approval is obtained during the preparation process for some elements of this document. Respective governing boards, or designees approve local plans and procedures reflected in this document that are not multi-jurisdictional. The San Joaquin Operational Area Council approves the multi-jurisdictional elements of the document. The existing agreements include:

1. Joint Hazardous Materials Team Agreement (County of San Joaquin, Cities of Stockton, Lodi, Tracy and Manteca, California Department of Transportation, and signatory rural fire districts).
2. San Joaquin Operational Area Agreements. Signatory information is maintained at San Joaquin County Office of Emergency Services

#### **1.5 Area Plan Update and Implementation (§2721 Area Plan Maintenance)**

This Area Plan is revised and updated on an ongoing 3-year cycle. The Joint Team Policy and Procedures is maintained on a yearly cycle because of the number of responses that occur, and the ongoing need to review and modify techniques the team uses.

#### **1.6 Area Plans Relationship to Other Plans**

The efforts of all jurisdictions and agencies of the County will include enhancing their ability to integrate all involved agencies and jurisdictions into a unified organization that will implement this standardized system. Joint preplanning activities will include setting up structures and policies to ensure that that integration occurs.

#### **1.7 Business Plan Information**

Please refer to the California Health and Safety Code, Section 25503 for the legal requirements for business plans.

Emergency plan and inventory information can now be transferred through an interactive website from businesses respective business plans to the Office of Emergency Services. Responders and field personnel can access this data through the Office of Emergency Services web site. This system for gathering and sharing information on business and plans greatly enhances the quality of plans, reduces workload, and ensures faster access.

Businesses certify their plans and inventories are correct on an annual basis although changes are received year round.

### 1.7.1 Integrating Business Information into Area Plan

Strategic response planning is accomplished by incorporating information from the business emergency and risk management plans into this Area Plan. For instance, facilities with large quantities of a regulated substance, which pose a threat to large populated areas, may become candidates for a large-scale exercise of this Area Plan. Such drills at local business facilities involving Joint HAZMAT Team members and many other response disciplines have become common in the San Joaquin Operational Area. Enough businesses have requested such drills that there is now a waiting list.

## 1.8 **Ensuring Business Plan Accuracy and Pre-Incident Surveys**

As Administering Agency, the County Office of Emergency Services conducts activities to enhance business preparedness under State statutes.<sup>6/</sup> These include identification of businesses using over 55 gallons, 500 pounds, or 200 cubic feet of a hazardous material for regulation.<sup>7/</sup> They also include review of mandated business emergency plans with the specific goal of preventing or minimizing incidents. Business inspections include safety comments and confirmation of inventories, training documentation, and business plan information. Preplanning for specific facilities is not performed during inspections.

### 1.8.1 Fire Department Access to Program Data

Business plans and inventories, site maps, and specific response information are available to fire and police departments. These local agencies are responsible for developing site-specific response preplans using the information gathered by the Administering Agency.

Fire districts can generate lists of businesses handling hazardous materials in order to identify fixed potential hazards for additional planning. The highest priority is potential hazards near concentrations of senior citizen residences, schools and day care centers, and non-English speaking populations.

## 1.9 **RMP - Acutely Hazardous Materials**

Handlers of acutely hazardous materials must comply with the Risk Management Program identified under the California Accidental Release Prevention Program (CalARP) regulations.<sup>8/</sup> This program incorporates hazard evaluation techniques and risk reduction strategies to be used by businesses to manage acutely hazardous materials.

Businesses regulated under the CalARP are required to comply with the Federal Risk Management Program and/or the California Program as appropriate. These facilities receive inspections, risk reduction plan reviews and audits for program compliance. Initial Completion

---

<sup>6</sup> §25500, Article 1, Chapter 6.95, Division 20, Health and Safety Code

<sup>7</sup> §25508 and §25185, Article 1, Chapter 6.95, Division 20, Health and Safety Code

<sup>8</sup> §2735.1, Article 1, Chapter 4.5, Division 2, Title 19, California Code of Regulations

Criteria Review Sessions initiate a dialog between the Administering Agency and business aimed at establishing a one-year plan development and submission process. The Administering Agency remains involved in risk reduction strategy.

Part of this process is the creation of an operational area map locating large quantity handlers of regulated substances.

### **1.10 Area Plan Checklist**

Criteria for developing Area Plan content is analyzed from three different regulatory programs during update cycles. These are Chapter 6.95 of the Health & Safety Code for basic Area Plan content, and the California Department of Fish & Game and United States Coast Guard programs for development of oil spill plans.

**SECTION 2: PROCEDURES AND PROTOCOL  
FOR EMERGENCY RESPONSE PERSONNEL**  
(§2722 H&S, §4460 UCS)

**2.1 References to Follow During Incidents**

The following documents constitute the actual authorities for initial response from demobilization to clean up activities. Specific procedures for each jurisdiction are listed since agencies will need to follow both Area Plan and local procedures. Some of these documents are contained in the appendices of this document and others are referenced here only.

2.1.1 Emergency Operations Plans

1. City of Escalon Emergency Operations Plan
2. City of Lathrop Emergency Operations Plan
3. City of Lodi Emergency Operations Plan
4. City of Manteca Emergency Operations Plan
5. City of Ripon Emergency Operations Plan
6. City of Stockton Emergency Operations Plan
7. City of Tracy Emergency Operations Plan
8. San Joaquin County Emergency Operations Plan
9. San Joaquin Operational Area Emergency Operations Center Procedures
- 10.

2.1.2 Joint Team, State of California, and Federal Procedures

1. Joint Hazardous Materials Team Operational Guidelines, Procedures, and Equipment Manual
2. State of California Hazardous Materials Incident Contingency Plan
3. United States Coast Guard 11<sup>th</sup> District Area Contingency Plan

2.1.3 Communications Centers

1. San Joaquin Area Emergency Alert System Plan

2. San Joaquin Operational Area Multi-Agency Coordination System Procedures
3. County of San Joaquin Sheriff's Communications Center Procedures
4. City of Stockton Fire Department Communications Center Procedures
5. Lifecom Communication Center Procedures

## **2.2 Approach, Recognition, and Evaluation of Incidents**

Local, state, and federal agencies provide statutory awareness training (see Section 5 – Training) to personnel that may come upon a release or threatened release. This defensive level training covers basic recognition, material evaluation, and initial notification procedures. It does not provide offensive level training.

### **2.2.1 Approach and Evaluation**

Approach, entry, and physical evaluation activities are covered in the Hazardous Materials Technician and Specialty level training. Joint Team Policy, Section §13, describes how team members with that level of training will approach and evaluate unknown materials, or threats of unknown materials.

## **2.3 Identifying Potential Release Impacts**

Responsibility to determine the potential hazards and impact of a release or threat of a release is that of the Assistant Safety Officer. These protocols are found in the Joint Team Policy, Sections §12 and §14.

## **2.4 Personal Protective Equipment and Emergency Equipment Guidelines**

Joint Team Policy, Section §13, describes the process to select appropriate equipment to protect responders for entry operations and cleanup.

## **2.5 Monitoring and Decontamination Guidelines**

Guidelines for conducting decontamination and facility protection actions can be found in the Joint HAZMAT Team (JHT) Policy. These decontamination protocols identify equipment, procedures, and responsibilities for incidents ranging from a small routine incident to complex multi-casualty incidents.

- Monitoring procedures is found in Section §6, Medical Surveillance Policy.

- Decontamination procedures are found in Section §14. Mass decontamination for non-responders is in Section §15.

## **SECTION 3: PRE-EMERGENCY PLANNING** (§2723 H&S, §1561.15 UCS)

### **3.1 General**

The County of San Joaquin has established a prevention program as part of its response system. In addition, ongoing preplanning occurs to address the diverse capabilities needed for effective response if an incident does take place. Cities and special districts participate in this effort through the processes identified below.

### **3.2 Pre-Emergency Planning and Coordination**

Coordination with industry occurs during fire code inspections, business plans inspections, and individual contacts. Site specific planning and coordination for response to a hazardous material incident occurs at the city and special district level.

### **3.3 Industry Coordination**

A business plan is required to be developed by a business as defined in regulation.<sup>9</sup> This plan addresses emergency response by employees.<sup>10/</sup> An employer response plan is also required under the Federal Resource Conservation and Recovery Act of 1976 (RCRA).<sup>11/</sup>

These statutes describe the employers' responsibility to develop the response plan, elements of the plan, and procedures for handling emergency incidents. The plan shall address how the private business employer will interact with the public sector emergency responder at the time of an incident.

### **3.4 Coordination Between Agencies**

#### **3.4.1 San Joaquin Operational Area Council**

General emergency response coordination of jurisdictions within the County occurs through the San Joaquin Operational Area Council. This Council meets periodically for review and approval of disaster and emergency plans. The Council establishes working groups to address specific issues such as hazardous materials. A copy of the description and membership of the San Joaquin Operational Area Council is available in the County Office of Emergency Services.

---

<sup>9</sup> California Health and Safety Code, Section 25503

<sup>10</sup> 29 CFR 1910.120 (1)(1)(i)

<sup>11</sup> 29 CFR 1910.120 (p) (8)(i)



#### 3.4.2 Fire Chiefs' Association Special Operations Committee

This multi-disciplinary standing committee meets monthly or on an as-needed basis. The committee performs emergency planning tasks regarding hazardous materials, Urban Search & Rescue and other issues involving the fire services.

#### 3.4.3 San Joaquin County Toxic Enforcement Strike Force

The San Joaquin County Office of the District Attorney conducts monthly meetings to provide an open forum for agencies to discuss current issues. These issues may concern hazardous materials or waste enforcement, and strategies for obtaining compliance with current regulations. Agencies participating include the San Joaquin County Office of Emergency Services, San Joaquin County Environmental Health Division (CUPA), California Department of Fish and Game, the Regional Water Quality Control Board, the San Joaquin County Sheriff's Office, several municipal utility districts, the San Joaquin County Agricultural Commissioner's Office, and others.

#### 3.4.4 Joint Team Steering Committee

This steering committee meets periodically to review changes in policies, procedures, training needs, plans and other response related issues. There are sub-committees focusing on specific issues such as equipment and training.

#### 3.4.5 Weapons of Mass Destruction Steering Committee

This committee meets on an as-needed basis, depending on pending issues, to coordinate the implementation of standardized methods for response of chemical or biological incidents.

#### 3.4.6 County Public Health and Pesticide Drift Protocols

The San Joaquin County Public Health Department shall meet at least annually with other emergency response agencies to present information on the health hazards and what may be expected by Incident Commanders, emergency responders when called to a pesticide drift incident. This meeting can also be used to plan and set up an annual tabletop or full-scale exercise based on pesticide drift.

#### 3.4.7 State and Federal Coordination

San Joaquin County as an Organizational Area is recognized in many State and federal plans as an involved agency requiring interaction with that respective agency. The Administering Agency recognized as the Office of Emergency Services shall coordinate and assist with any calls placed upon the Organizational Area by other agencies. Such agencies can include, but

is not limited to, California State Fish and Game, Lawrence Livermore National Laboratory (Site 300), and the United States Coast Guard.

### 3.5 Mutual Aid Agreements

#### 3.5.1 California Master Mutual Aid Agreement

Public safety agencies provide mutual aid to other jurisdictions under the provisions of the California Master Mutual Aid Agreement. Under this agreement, the State Office of Emergency Services has the responsibility to extend hazardous materials technical functions mutual aid between other counties.

#### 3.5.2 San Joaquin County Fire Service Mutual Aid Agreement

A separate mutual aid agreement exists between the County fire districts. A copy of existing mutual aid agreements can be found in the San Joaquin County Emergency Operations Plan. These agreements, along with other response agreements, ensure that any jurisdiction can obtain personnel to fill all positions of the pre-established County Incident Command System structure for hazardous material incidents. See Attachment #1 for details.

#### 3.5.3 Joint Hazardous Materials Technician/Specialist Mutual Aid

Many jurisdictions maintain personnel trained and equipped to perform specialized entry and mitigation positions of the Hazardous Materials Group function found in the Incident Command System response structure.<sup>12/</sup> Several of these agencies also maintain specialized equipment and vehicles. Automatic mutual aid is provided through the "Agreement for Hazardous Materials Team within San Joaquin County." A copy of the agreement is included in Appendix #12. All agencies with hazardous materials response capabilities have signed the agreement.

#### 3.5.4 Out of County Agreements

San Joaquin County has a special hazardous materials mutual aid agreement in place with Amador County. See Appendix #12 – Agreement for Participation in Central Valley Hazardous Materials Response System). Systems and provisions exist for traditional mutual aid to other counties and jurisdictions under the Master Mutual Aid Agreement.

#### 3.5.5 Private Business or Facilities Agreements

San Joaquin County does not have any specific or informal agreements with businesses or facilities that could provide mutual aid. However, agreements could be made on a case-by-case basis if the need arises during emergency operations.

### 3.6 Activation/Deactivation of Emergency Response Agencies

Activation and deactivation of emergency responders are conducted under ICS standard protocols. The San Joaquin Joint Hazardous Materials Team Policies and Procedures Manual outlines activation and deactivation procedures for hazardous materials incidents. For major medical disasters, deactivation guidelines are found in the Region IV Multi-Casualty Plan. Activation and deactivation procedures for all other disasters such as floods, earthquakes, and wild land fires are conducted under SEMS guidance documents and mutual aid agreements.

### 3.7 Access to Funding

The Incident Commander is responsible for financial decisions made to handle the incident. However, certain funds are available for specific aspects of the hazardous material mitigation. Appendix #6 (12.6.5) provides details on obtaining local, state, and federal funds for cleanup activities.

#### 3.7.1 Reimbursement/Cost Recovery Options

The County Office of Emergency Services, acting in its coordinating role will assist local agencies to access federal and state disaster assistance programs.<sup>13/</sup> Few of these programs focus specifically on hazardous material incidents. Most of these programs are for major incidents involving state and federal disaster declarations.

#### 3.7.2 Cost Recovery From Responsible Parties

The Incident Planning/Intelligence Section should package up all documentation so the Incident Commander's agency can pursue any available reimbursement processes. The responsible party or business will be responsible for any claims. If responding or helping agencies generate records, then a copy should be provided. If cost recovery is coordinated through the Incident Commander, then records can be provided as well.

---

<sup>13</sup> Robert T. Stafford Disaster Relief and Emergency Act, Public Law 93-288, as amended.

Title 44, Code of Federal Regulations, Part 206.

Natural Disaster Assistance Act, as amended: §8680 through 8692, Article 1-5, Chapter 7.5, Division 1, Title 2, California Government Code.

### 3.8 Access to Disposal Facilities and Contractors

Jurisdictions are responsible for maintaining procedures and funds for obtaining emergency clean up contractors for spills without a responsible party. The Environmental Health Division maintains lists of available contractors for use by all agencies. The County Office of Emergency Services arranges cleanup on County road right of ways.

#### 3.8.1 Available Disposal Sites

There are no full service hazardous waste facilities in San Joaquin County. Waste removal businesses transport material out-of-county after pick up. There are several options for small quantity waste for emergency response agencies.

California Department of Transportation (CalTrans): The CalTrans facility in Stockton provides a temporary storage facility for short-term storage of small quantities of low risk waste in return for the option of Joint Hazardous Materials Team response to spills on their jurisdiction.

San Joaquin County Household Hazardous Waste Facility: Near the Stockton Metropolitan Airport, this facility is primarily for small-volume household disposal. However, they can be used for the disposal of unique waste streams such as blood-contaminated waste (pathogens).

### 3.9 State Authority to Approving Funding

Funding for removal of hazardous wastes from spills or clandestine drug laboratories including roadside and off highway abandonment is available from the Department of Toxic Substances Control (DTSC). A September 4, 1998 letter issued by that agency describes the process for accessing these funds. Guidance documents describing criteria and processes for accessing the Emergency Reserve Account (ERA) and the Illegal Drug Lab Cleanup Account (IDLCA) are included in Appendix 6 (12.6.5). The DTSC can be contacted during workday hours at (800) 260-3972. After hours the DTSC Duty Officer can be contacted via the State Warning Center at (800) 852-7550.

### 3.10 Incident Management Organization

The San Joaquin County response system is based on the Incident Command System models as approved by SEMS, FIREScope, and National Wildfire Coordinating group. See Attachment #1 (12.1.1 – 12.1.4). Under this system a County specific organizational scheme is in place called the "Standardized ICS Structure for Hazardous Materials Incidents."<sup>14</sup>

---

<sup>14</sup> CFR 1910.120(q)(3)(11)

### 3.11 Agency Functional Responsibility Matrix (Attachment 3)

This matrix identifies agencies assigned to fill specific roles in the county ICS structure. The detailed position duty statements included in this plan further define specific ICS positions shown on the matrix. Agencies shown, as having primary responsibility for an ICS function will fill those functional positions if sufficient personnel are available. Agencies with secondary responsibility for a function will fill those functional positions when the primary agency cannot fill the positions. If appropriate, State and federal representatives will be assigned to appropriate functions within this response organization.

County agencies and jurisdictions have now developed additional ICS-207 Organizational Charts for response to Weapons of Mass Destruction incidents. These charts identify agency assignments for WMD response in the San Joaquin Operational Area for biological and non-biological events:

- Weapons of Mass Destruction Incident - Non-Biological Threat. Attachment #1
- Weapons of Mass Destruction - Biological Threat. Attachment #1
- Hazardous Materials Responsibility Matrix that identifies agency responsibility. Attachment #3
- Map and Description of USCG/EPA Boundary, Attachment #4

### 3.12 Phases of Incident

#### 3.12.1 Initial Response Phase

Once a release occurs, or threatens to occur, the response system described in this plan is initiated. The responsibilities of first response agencies (e.g., fire, law enforcement, medical) include deciding whether a hazardous material is involved, protecting responders and the public, and mobilizing appropriate additional resources. They protect the public through rescue, area isolation or evacuations, and containment actions that do not present a high exposure risk to first responders.

#### 3.12.2 Criteria for change in Phase

The Incident Commander shall determine the change from Initial Response to Control and Stabilization when on-scene resources are in place and adequate to begin mitigating the hazard. The change shall take place when initial efforts to warn and/or protect the public, initial isolation practices have been taken as well as any basic containment actions are complete. Once this has been done, the incident can be moved into the Control and Stabilization Phase.

### 3.12.3 Control and Stabilization Phase

First responders will mobilize appropriate resources that can undertake specialized activities. These activities may include public health protection and monitoring, entry into contaminated zones, hazard identification and containment, and investigation. The County is presently able to support on-scene activities, if warranted, with resource and command coordination capabilities through mobile field command posts and local emergency operations centers.

If local resources are inadequate, the San Joaquin County Office of Emergency Services, serving as the Operational Area Organization, and the local mutual aid coordinators will access additional resources through mutual aid agreements.

## 3.13 **Command Structure and Responsibilities**

Position descriptions (Attachment 3) are intended to ensure proper role definition, prevent duplication or failure to undertake needed actions, and to improve coordination among multiple responding agencies.

Local agencies and locally based state agencies with legal or procedural responsibilities will fill the appropriate positions of the standard ICS structure. Duties and responsibilities for each position are clearly identified with references to specific policies and/or procedures. Some of these detailed procedures are in Appendix 5 of this plan.

### 3.13.1 Incident Command

An Incident Commander, or Unified Incident Command, will be established at all incidents. Incident management authority is established by regulation, ordinance, jurisdictional establishment, financial, policy, or written agreement. See Attachment 1 for San Joaquin Operational Area incident command authorities.

Where Incident Command jurisdiction is unclear, or where the incident command agency is not present, first response agencies will identify an Incident Commander among themselves or will establish a unified command until the appropriate jurisdiction is identified.

### 3.13.2 Transfer of Incident Command

Incident Command may be transferred to another agency or a Unified Command of multiple agencies when jurisdiction or responsibility for the incident changes. The Incident Command can transfer once the situation stabilizes. With the agreement of involved agencies, transfer can occur when the Initial Response Phase is over and the Control and Stabilization Phase begins.

### **3.14 Control and Stabilization Phase**

Once initial response objectives are accomplished, the response system is prepared to shift control to long-term stabilization activities. The Joint Team will make entry and stop any release, contain the spill and identify materials involved. The San Joaquin County Environmental Health Division is responsible for making final identification of the material, monitoring cleanup, undertaking exposure monitoring and follow up, and preparing necessary mitigation reports and documentation. The District Attorney's Office will coordinate efforts to establish liability for the incident.

#### **3.14.1 Private Sector Role**

In many cases, the private sector may be involved with some or all phases of an incident. When a private sector Responsible Party (RP) has been identified, the RP shall manage the incident to the best of their ability, training and resources as part of the Unified Command. With large industries and facilities, the RP may take on the role of sole IC if appropriate. This is especially true if the incident initiates from, or is on private property. Under San Joaquin County policy, a private sector RP under any part of Unified Command shall not command public sector resources. If the Incident Command is to remain with local law enforcement or other public agency, the RP shall work within the IC structure to coordinate their contractor hiring, cost recovery and cleanup responsibilities. It shall be the responsibility of County Environmental Health to ensure proper cleanup is conducted by the RP as well as that proper disposal techniques and procedures are used. County Environmental Health shall also work with an RP to ensure that cleanup operations are continued until the hazard is mitigated as best as required by law.

As referenced in section 3.5.5 of this plan, the county does not have any pre-arranged agreements with the private sector for the use of resources on incidents beyond the responsibility of a private sector entity.

### **3.15 Response Termination Phase**

In order to ensure all involved parties are in agreement when a response should be terminated, any agency directly involved in the operation shall communicate their criteria for demobilization to each other beforehand. The Control and Stabilization Phase shall not change into the Response Termination Phase until all involved agencies are in concurrence that such a change can take place. Specific agencies such as local law enforcement may defer this decision to other agencies such as County Environmental Health if agreed upon beforehand.

**SECTION 4: NOTIFICATION AND COORDINATION**  
(§2724 H&S, 1550/1560 UCS)

**4.1 Communications Planning Agencies**

The San Joaquin Operational Area is served by a 9-1-1 system with seven Public Safety Answering Points (PSAP). The California Highway Patrol handles reports made with cellular telephones.

4.1.1 Communications Planning Meetings

San Joaquin County has established a countywide communication committee. As part of this committee, the San Joaquin County Information Systems Division (ISD) is to coordinate current systems, enhancements and interoperability.

**4.2 Notification Procedures**

Responsible Parties: Individuals, businesses, or public agencies that cause a hazardous materials release are legally required to notify local emergency response agencies, the local Administering Agency, and the California Office of Emergency Services Warning Center.<sup>15/</sup> The business is required to establish an incident command system when an incident occurs pending arrival of first responders.<sup>16/</sup> Notification requirements are described in Attachment 10 – San Joaquin Operational Area Notification Requirements.

Public Safety Agencies: First response public safety agencies are responsible for establishing an Incident Command at hazardous material incidents. The Incident Commander is responsible for determining what resources are needed to control the incident and for initiating necessary resource requests and legal notifications. Normally, this communication will be done through a public safety access point.

Public Safety Answering Points (PSAP): PSAPs are responsible for notifying first response public safety agencies of incidents reported by the public. PSAP dispatchers can contact duty officers of the Office of Emergency Services, the Environmental Health Division, and the District Attorney's Office through the Sheriff's Communications Center.

PSAP dispatchers maintain telephone numbers for notifying the local Red Cross, Agricultural Commissioner's Office, Public Utilities, local Public Works agencies, and the State Warning Center. The Sheriff's Communications Center and the Stockton Fire Department

---

<sup>15</sup> §25507, Article 1, Chapter 6.95, Division 20, Health and Safety Code

<sup>16</sup> §5192(q)(3)(a), California Code of Regulations [29 CFR 1910.120 (q)(3)(i)]



Communications Center maintain the call-out procedures for the San Joaquin Joint Hazardous Material Team (see Appendix 12).

San Joaquin County Sheriff's Communications Center: This dispatch center has direct responsibility for notification of the on-call duty officer for the Office of Emergency Services, the Environmental Health Division, and the District Attorney's Office. Any public safety agency can use this center for contacting those resources. The dispatch center is also the designated California Office of Emergency Services OASIS 24-hour contact for the Operational Area.

San Joaquin County Office of Emergency Services: This agency serves as the County Administering Agency for receiving release notifications. This agency will help, upon request, with notifications of local agencies regarding hazardous materials incidents to meet legal or resource needs. OES staff will also notify the members of the Emergency Services Council, the State Warning Center, and local, state and federal agencies with responsibilities or response capabilities as appropriate.

Emergency Medical Services: The Multi-Casualty Branch Director or Medical Group Supervisor is responsible for situations involving multiple victims. When multiple victims are potentially involved, contaminated or not, the on-scene Multi-Casualty Branch Director or Medical Group Supervisor will notify the County Control Facility (San Joaquin General Hospital) via appropriate radio channels. This facility will notify all potentially involved medical or health facilities and the Regional Poison Control Center through its blast conference call system or the VHF Area MEDNET radio channel.

#### 4.2.1 Notification Telephone Numbers

See Attachment 10 for the list of notification telephone numbers.

On an annual basis, the list of telephone numbers shall be called to verify accuracy and to note any changes. Any change in a telephone number shall be noted in Attachment 10.

### 4.3 **Communications Plan**

On-Scene Communications: The Incident Commander is responsible for coordinating communications during an emergency. A Communications Unit Leader could be assigned to perform this function of developing an incident communications plan to manage radio and telephone operations. CALCORD, a State radio frequency designated for multi agency on-scene coordination, can be used for establishing a common command channel for local and outside agencies. Local, state, and federal frequencies in portable radio caches and various mobile support units in the County are available through the mutual aid system.

Support Units: A binder listing each support unit is located with each PSAP. This allows the PSAP to best identify the resources required on scene at an incident.

The Operational Area Satellite Information System (OASIS)/ State Local Government Radio System: Available for communications with the State and surrounding counties.

Computer Paging System: Most communication centers are equipped with computers to send computerized messages. These messages are broadcast to a network of key individuals in order to begin and coordinate response activity ranging from small single agency response to a large multi-agency response. Several hazardous material responders also programmed portable computers to send messages from the incident site.

Radio Frequency Capabilities: The Operational Area MACS organization can talk over multiple channels with fire, law, public works, and other agencies within the cities of the Operational Area.

#### 4.3.1 Radio Frequencies

A Radio Frequency Chart for the Operational Area is to be developed.

Cellular Phone Capabilities: All hazardous material emergency vehicles are equipped with cellular telephones. Duty Officers and supervisors of the Office of Emergency Services carry cellular telephones as a back up to the vehicle mounted equipment. Equipment in some OES vehicles can also connect to paging and Internet services via cellular telephone.

#### 4.3.2 Alternate Means of Communications

The County and some cities maintain a Radio Amateur Civil Emergency Service (R.A.C.E.S.) program for supplementing normal communications. An Incident Commander can request this service through the Office of Emergency Services. RACES operators are volunteers covered under the State Disaster Service Worker program.

### 4.4 **Response Agency Coordination Roles**

#### 4.4.1 Local Agency Response

At the local level the San Joaquin Operational Area will assist in coordination of public agencies and businesses from the private sector during emergency response.<sup>17/</sup> Incident coordination, pre-planned assignments, management and mitigation requirements will depend on the size of the incident.

#### 4.4.2 Operational Area

Multi-Agency Coordination System: The Office of Emergency Services operates the Operational Area Multi-Agency Coordination System (MACS) to assist in intelligence sharing, resource management, and jurisdictional coordination. The MACS center at 2101 E. Earhart Ave, Stockton, is equipped with various radio, telephone, and intra/internet systems to enable communications with incident commands and emergency operations centers of other jurisdictions.

Disaster Welfare Inquiries: OES can operate a center for collecting information on victims and distributing this to involved emergency medical agencies, the Incident Command staff, and the relatives of victims. The local Red Cross-staffs Disaster Welfare Inquiry Teams in the Operational Area Emergency Operations Center and at their chapter that perform this function.<sup>18/</sup> Additional personnel from the Behavioral Health Department, the Coroner's Office, or the Human Services Agency may also be involved. Cities may elect to perform this function themselves.

Environmental Health Department: This department serves as the Certified Unified Program Agency (CUPA) for the County. The Environmental Health Department is generally responsible for coordinating with local, state and federal agencies with cleanup responsibilities and authorities to determine the public health risks of an incident.

#### 4.4.3 Local Emergency Proclamations and Declarations

An incident may or may not require a "Proclamation of Local Emergency" by a designated official with one of the cities or the County. Special districts cannot proclaim an emergency. The Local Health Officer may issue a "Declaration of a Local Health Emergency" if emergency measures are needed to prevent a serious threat to public health.<sup>19/</sup>

---

<sup>17</sup> Public agencies can include fire, law, emergency medical service, public works, special districts, utilities, and environmental health services. Some may be locally based state and federal agencies.

<sup>18</sup> Details of this are in the Memorandum of Understanding between the American Red Cross and San Joaquin County and the County Multi-Casualty Incident Plan

<sup>19</sup> §8630, Article 14, Chapter 7, Division 1, Title 2, California Government Code

- 62 Ops.Atty.Gen. 710, 11-16-79

- §101085, Article 2, Chapter 2, Part 3, Division 101, Health and Safety Code

Protocols for making such proclamations or declarations will be consistent with the State Emergency Plan and Government Code.<sup>20/</sup> Access to State assistance available under a proclamation or declaration will be through the State Mutual Aid Region using the Response Information Management System (RIMS).

#### 4.4.4 Regional and Statewide Response

A locally based State agency can be the Incident Commander for a local incident. Such a situation would still be considered a local response. If an incident overwhelms local capabilities or is forecast to deplete available local resources, the Operational Area may request the State to seek resources in the 11-county region (OES Region IV), or statewide.

#### 4.4.5 Federal Agency Response

Within the San Joaquin Operational Area there are federal jurisdictions involving water conveyance systems (canals and San Joaquin Delta), military bases and other institutions. Responses to non-staffed federal facilities such as the Delta-Mendota Canal will involve an initial response by the local agencies with subsequent notification to the Federal Authority.

Local responders will also initially respond to incidents in the Delta. They manage the incident and cleanup when an incident involves a private responsible entity such as a private vessel or a private marina and is a small spill. Spills not under the responsibility of a private party, or large spills that are imminent threats to persons or environment, will require immediate notification of the Federal On-Scene Coordinator (FOSC). This can be United States Coast Guard, Environmental Protection Agency, or Department of Defense. Initial notification can be made through the United States Coast Guard National Response Center.<sup>21</sup> Telephone numbers for federal agencies are available from the San Joaquin County Office of Emergency Services.

Response to military bases and other federal fixed facilities will be dictated by the potential threat to the public and/or environment. Federal resources at the site will make initial response with local responders notified to help manage the incident. In a stable incident, mitigation and cleanup will be left to the federal agency with responsibility for that site.

### 4.5 **California Hazardous Materials Incident Report System (CHMIRS)**

The State of California requires submission of a report following an incident. It is the responsibility of the agency or business making notification to the State Warning Center to

---

<sup>20</sup> §8607, Article 9.5, Chapter 7, Division 2, Title 2, California Government Code

complete required paperwork of the California Hazardous Materials Incident Report System (CHMIRS).

Incidents in the San Joaquin Operational Area that result in ground, water, and air contamination, or incidents resulting in human death or injury, will be reported to the State through the California Hazardous Materials Incident Report System (CHMIRS). The State Warning Center must receive an initial verbal incident report. An exception is of motor vehicle fluid spills of less than 40 gallons on roadway, sewage overflows, and leaks in low-pressure fuel lines to residential properties. <sup>22/</sup>

The Office of Emergency Services duty officer can help perform this notification for Incident Command. But if OES does not respond, or is not notified, it remains the responsibility of the owner/operator or designated agent, city, special district, or public entity to complete the CHMIRS report and notify the State Warning Center. <sup>23/</sup>

---

<sup>22</sup> Motor Vehicle Accident Spill Policy, County of San Joaquin Toxic Enforcement Strike Force.

<sup>23</sup> See attached “Notification Flow Decision Tree” from the California Hazardous Material Incident Contingency Plan.

## **SECTION 5: TRAINING** (§2725 H&S, §1830 UCS)

### **5.1 Business Training**

State law requires training business employees on their facility emergency plan. If requested, OES shall send training guidance to businesses participating in the Chapter 6.95 program.<sup>24/</sup> Businesses may also use outside training sources or conduct in-house training. The Office of Emergency Services reviews business-training records during the inspections of regulated businesses to verify the training is being performed.

### **5.2 First Responder**

First Responders will be trained according to OSHA regulations for hazardous material response.<sup>25/</sup> Most agencies in the County have interpreted these regulations as requiring training to the "First Responder, Operational Level" as shown in the Federal OSHA regulations. Provision of hazardous materials training is coordinated through the Fire Chiefs' Association Training Committee and other joint public agency training bodies.

### **5.3 Joint Hazardous Materials Steering Committee**

In the San Joaquin Joint Hazardous Materials Team Agreement, there is a provision for the establishment of a Joint Hazardous Materials Steering Committee. This committee shall coordinate and track training of agreement participants. This committee will centralize and track training records and medical surveillance records for all members of the Joint Hazardous Materials Team. The committee's priority is to maintain in current training and medical surveillance status the members of the Joint Hazardous Materials Team that will fill the Hazardous Materials Group positions.

The Joint Hazardous Materials Steering Committee also coordinates a yearly training schedule for joint team classes, refresher training, drills, and exercises. The committee also will coordinate training courses for first responders as possible with given resources and will keep training records on attendees at committee sponsored courses or drills. Training schedules and information can be obtained from the County Office of Emergency Services.

---

<sup>24</sup> §25500, Article 1, Chapter 6.95, Division 20, Health and Safety Code

<sup>25</sup> §5192(q)(6), Article 109, Chapter 4, Division 1, Title 8, California Code of Regulations [29 CFR 1910.120]. 6

### 5.3.1 Standardized Emergency Management System (SEMS) and National Incident Management System (NIMS)

Standard Emergency Management System (SEMS) and National Incident Management Training (NIMS) training for all emergency response agencies will be encouraged (is required?). Local agencies are subject to loss of reimbursement of response funds if SEMS is not used.<sup>26/</sup> This system shall be applicable, but not limited to, those emergencies or disasters referenced in the state emergency plan. SEMS and NIMS cover emergencies or disasters involving multiple jurisdictions or multiple agency responses in the San Joaquin Operational Area. Each jurisdiction is required to maintain documentation of SEMS/NIMS training. The San Joaquin Office of Emergency Services will keep jurisdictions aware of planned integration to NIMS.

### 5.3.2 Hazardous Materials Response Training:

Responders to hazardous materials incidents in the San Joaquin Operational Area shall be trained to state and federal standards.<sup>27/</sup> The training elements and medical surveillance policies are in the San Joaquin Joint Hazardous Materials Response Team Policies and Procedures Manual Sections 5 and 6 respectively. Copies of these sections can be found in Appendix 12.

### 5.3.3 Hazardous Waste Site Emergency Response:

Responders to hazardous waste operations in the San Joaquin Operational Area shall be trained to the state standard.<sup>28/</sup>

## 5.4 **Incident Drills and Exercises**

Periodic drills or exercises will be scheduled to enhance readiness and test procedures. Drills will be aimed at skill learning or testing of an individual or equipment. Exercises will be aimed at evaluating procedures. At least three types of drills and exercises shall be performed: Tabletop Exercises, Hospital Drills, and Facility Drills:

### 5.4.1 Table Top Exercises

---

<sup>26</sup> §8607, Article 9.5, Chapter 7, Division 2, Title 2, California Government Code

<sup>27</sup> §5192(q)(6), Article 109, Chapter 4, Division 1, Title 8, California Code of Regulations [29 CFR 1919.120 (q)(6)]

<sup>28</sup> §Section 5192(l)(7) and (6), Article 109, Chapter 4, Division 1, Title 8, California Code of Regulations and RCRA

The Operational Area and its jurisdictions will hold periodic table top exercises to review changes or additions to procedures. Such exercises focus on the (field) command post, departmental operations center (DOC) or emergency operations center (EOC).

Pre-established Incident Command Teams may conduct a tabletop exercise to test how a hazardous material incident should be managed, e.g., decision-making, closing an area, evacuation planning, and containment procedures.

#### 5.4.2 Hospital Drills

Hospitals are required to perform two emergency drills a year, one internal drill without other facilities involved and one operational area wide drill. These drills test procedures in the Region IV Multi-Casualty Plan as well as internal facility procedures.

Some hospitals practice receiving victims exposed to hazardous materials during these drills. The San Joaquin County Joint Team also annually schedules several joint exercises with medical facilities to test joint operations. This gives the team and the facility an opportunity to test procedures for notification, decontamination, treatment, receiving advice from off-site centers, e.g., poison control, Centers for Disease Control, National Response Center and coordination with the Control Facility.

#### 5.4.3 Facility Drills

The Joint Team schedules a minimum of three drills a year at businesses that handle hazardous materials. This allows for skills testing of personnel, supplies, and equipment in a realistic environment. The drill also allows the team to become familiar with plans, safe routes of approach, multi-department communications, and layout of potential incident sites in the County.

#### 5.4.4 Planning and Scheduling Drills

Due to the variety in drills and participating agencies, the Joint Team shall ensure a schedule of drills is established that involves all agencies and builds up competencies and expertise. As such, an annual training schedule could start with tabletop exercises and progress towards a fully functional field exercise as experience and knowledge is gained.

At least one drill per year will address a pesticide drift related incident. Other agencies not normally involved in emergency operations such as the County Agricultural Commissioner shall be involved with this training. The County Public Health Department and Emergency Medical Services can also be involved since they have staff members who are specially trained in pesticide illness diagnosis and treatment.



#### 5.4.5 Functional Exercises

Periodically, a functional exercise will be conducted to test the operational readiness of procedures and plans. Such an exercise could be in conjunction with another agency-sponsored exercise.



### 6.3 Notification Systems

Operational Area agencies have attempted to standardize some notification systems so that authorized personnel can assist other jurisdictions with communications. An added benefit is ease of combining duplicated or similar notifications.

#### 6.3.1 Radio Communications Plan

The Joint Hazardous Materials Team Communication Plan (JHTCP) describing agency call signs, command net, tactical net and HAZMAT group channels is to be developed.

#### 6.3.2 Emergency Alert System (EAS)

This system is activated in accordance with the Emergency Alert System Area Plan for San Joaquin County. The Incident Commander is responsible for requesting system activation and approval of message content. Message coordination may take place at the operational area level to ensure coordinated communications with participants and consistency in public messages. An authorized activator must be contacted before the system is used.

The Emergency Alert System Area Plan for San Joaquin County (1992) contains specific procedures and policies for using the system. A copy is available at the San Joaquin County Office of Emergency Services.

#### 6.3.3 Emergency Digital Information System (EDIS)

EDIS was created to fill gaps in the state's existing Emergency Public Information system. It is designed to supplement the Emergency Alert System with a means of transmitting detailed information to the news media in text form. This is a priority concern of special populations such as the deaf and hearing-impaired. The system is based on a direct computer link to other agencies, media, and citizens feeding through the Internet, radio transmissions, e-mail, paging, and Teletype.

#### 6.3.4 City Watch

The Sheriff's Office has a computerized dialing system used for the Neighborhood Watch Program. This system will telephone all numbers in an identified area. The numbers are both listed and unlisted, provided by various telephone service providers.

#### 6.3.5 Radio Amateur Emergency Services (RACES)

The Radio Amateur Emergency Services can provide additional communication support to government agencies during emergencies within the San Joaquin Operational Area. If first-

line or mainstream communication systems are inoperable or overwhelmed, RACES can assist with HAM radio communications from emergency services to other governmental agencies and the general public.

#### 6.3.6 Emergency Advisory Radio Systems (EARS) and Radio Lodi

The Emergency Advisory Radio System (EARS) can utilize up to three portable AM transmitters that can be transported and set up throughout the county depending on the nature of the emergency. Verbal warnings along with local weather conditions can be broadcast informing motorists, residents and potentially evacuees what action to take during AMBER alerts, flood events, hazardous materials incidents and other types of emergencies that may be encountered. Broadcasts are continuous and can be kept up-to-date as conditions and stages of an emergency develop. San Joaquin County Emergency Services can broadcast on 530 and 1030 kHz on these portable AM transmitters.

The City of Lodi has a low-powered radio station that can broadcast information during an emergency. Like the EARS system, broadcasts can give information ranging from evacuation procedures and weather reports. Radio Lodi transmits on 1250 kHz and covers only the general Lodi area.

#### 6.3.7 Telephone Emergency Notification System (TENS)

The Telephone Emergency Notifications System (TENS) is a high-speed communications system that sends emergency information or warnings to designated geographic areas. TENS is a combination of telephone, computer and Geographic Information System (GIS) technologies. The City of Stockton, San Joaquin County Sheriff, and the City of Manteca have these types of systems in place. The City of Stockton and the County Sheriff use the same system and can link with each other during emergency operations.

#### 6.3.8 Office of Emergency Services Website

The Office of Emergency Services maintains a website that offers both general information for emergency services and specific information posted for an emergency. This site is configured to isolate separate web pages for specific jurisdictions until their sites are ready to supply direct information.

### 6.4 **Notification Procedures**

Hazardous material incidents involving a threat to life or health of the community may involve many jurisdictions in emergency response and command actions. The Incident Command System assigns the Incident Commander final authority in approving information to be released.

Once cleared, the Information Officer (IO) is tasked to appropriately handle the task of distribution of safety information to the public and to responders. The initial notification of the public and ongoing information dissemination through the private media, are covered in the Emergency Alert System Plan. Some of the communication systems covered in previous sub-section are used depending on the urgency and degree of threat to life and property.

#### 6.4.1 Central Information Clearing House

It may be necessary to activate an Emergency Operations Center (EOC) or Department Operations Center (DOC) to assist with the dissemination of safety information. The Annex I Communication Process will be used to establish an appropriate risk communication structure.

The Operational Area and most cities have specific guidance for activating, staffing, and maintaining an Emergency Operations Center.<sup>30/</sup> A local incident command could disseminate messages by various local warning methods. Incident Command can also request an Information Officer at the appropriate Emergency Operations Center to coordinate and distribute public safety information through the EAS or other system. A city or Operational Area EOC should be activated to assist if the incident becomes large or resource needs extend to a regional or multi-regional level.<sup>31/</sup>

The Planning/Intelligence Section Chief, Information Officer, and Communications Manager within an Emergency Operations Center or Department Operations Center will coordinate with the EOC Director to issue public safety statements. The EOC will also establish a public information-clearing house for responding to concerns from the community, families of affected individuals, and media inquiries.

#### 6.4.2 Timely Notification

The Incident Information Officer is normally the person responsible for developing procedures for message formats, time frames, and addresses. The Incident Commander retains final authority of content approval. The intensity, complexity, and pace of the incident dictate the time frame for message delivery.

---

<sup>30</sup> San Joaquin Operational Area MACS Procedures manual

<sup>31</sup> Emergency Alert System (EAS), Emergency Voice Mail System (EVMS), and Emergency Digital Information System (EDIS) are key public information methods. Response Information Management System (RIMS) is a computerized database system maintained by State OES for local, Operational Area, selected state and federal agencies to share information and resource needs.

Emergency Alert System messages can be processed from the incident site and can be set for repetition at 15 minute to 3hours/30 minute time durations. A time delay could occur if the incident commander agency is not an authorized EAS activator.

For all other notification systems, Incident Commanders will anticipate a need for some processing time. The Sheriff Telephone Emergency Notification System (TENS) must receive detailed instructions of agencies to contact and information to relay. The Emergency Digital Information System requires the information to be processed from an Internet accessible computer, and by an authorized user.

## 6.5 Evacuations and Shelter-in-Place Actions

Large-scale incidents posing a threat to facility employees or the community may require an evacuation or rescue plan. In cases involving mobile contaminants such as a toxic plume, protective actions may involve “shelter-in-place” recommendations in place of evacuation. The county will not make a recommendation to evacuate or call for voluntary evacuations. The county policy is to proclaim only for immediate evacuation or shelter-in-place.

An evacuation function in the Operations Section should be formed if evacuations are anticipated. Peace officers and local health officers have the authority to close the scene so they should be considered for the evacuation group supervisor position.<sup>32/</sup> To assist this type of operation and the responsibilities of the Peace Officers and Health Officers, OES has developed Evacuation Maps that offer guidance with routes, assembly areas, Incident Command structure and vulnerable populations.

The Incident Commander or Unified Command will have the responsibility for deciding protective actions (e.g., evacuation immediate, shelter-in-place) with the business Incident Commander.

The ICS structure position descriptions include specific procedures and responsibilities for helping the Incident Command in making and carrying out these decisions. Actual authority to close an area resides in a peace officer or the local health officer.<sup>33/</sup>

### 6.5.1 Centralized Coordination of Agency Information

The Operational Area Emergency Operations Center may coordinate the release of safety information to the public for individual or multiple jurisdictions. The San Joaquin Operational Area Information Officer (IO) works with all other information officers on developing public information content and distribution methodology through a Joint Information Center. The Joint Information Center is generally co-located with the

---

<sup>32</sup> §409.5, Title 11, Part 1, California Penal Code

<sup>33</sup> §409.5, Title 11, Part 1, California Penal Code

Emergency Operations Center. Telephone operators in the Emergency Operations Center can help with the handling of public and media calls for information.

The San Joaquin Operational Area Information Officer and the Information Officer assigned to the Incident Command will conduct periodic conference calls to coordinate information and media releases. If the Incident Command does not want this type of assistance, then the Operational Area will refer requests for information to the designated Incident Command Information Officer.

#### 6.5.2 Coordination Checklist

SEMS ICS has standardized checklists for all positions within the generic system. This includes Hazardous Materials positions. Attachment 3 of this plan describes additional tasks that have been developed for ICS positions that are specific to this Operational Area.

Additional position checklists to deal with the special concerns for biological and non-biological weapons of mass destruction incidents are also included in Appendix 4.

Checklists have also been developed for Operational Area EOC positions to assist in coordination of area events. If more than one jurisdiction is involved, Area Command procedures have been developed to resolve conflicting incident command objectives.

### 6.6 **Sharing Potential Hazards and Hazardous Materials Properties**

First responders will make an initial site assessment. Once the Hazardous Materials Group is activated, a Technical Reference position is assigned to work with the Assistant Safety Officer and team members to identify hazards. Where a representative of the party responsible for the spill is available and is knowledgeable of the chemicals present, the Technical Reference will work closely with that person to identify risks. An attempt will be made to obtain a Material Safety Data Sheet (MSDS) or other technical documents to aid in determining material properties.

Identification of potentially hazardous substances will be through sampling of the material or air monitoring. Material sampling will be performed with a hazard categorization test kit, pesticide test kits and reagents, drug lab test kit and reagents and their respective testing procedures.<sup>34/</sup> For air monitoring, a combustible gas indicator, colorimetric tubes, halogen detector or radiological survey equipment will be used. A form will be completed to document test results and note identified characteristics of chemicals.

#### 6.6.1 Information on Pesticides

---

<sup>34</sup> San Joaquin Operational Area “hazmat teams” use “HazCat®” as the categorization test kit of choice.

At the beginning of each year, the County Agricultural Commissioner (CAC) shall create and disseminate a list of the top 25 to 50 most commonly used agricultural chemicals. The list should focus on those types of pesticides that are most apt to become airborne. A copy of this list shall be provided to the County of Emergency Services and other emergency responders such as Fire Departments and Hazmat Teams. Any agricultural chemical trade name should be found or can be cross-referenced in the “Farm Chemical Handbook.” In addition, copies of the relevant Material Safety Data Sheets shall be kept by the Agricultural Commissioner’s Office and by the Office of Emergency Services. The CAC, through Unified Command can assist in informing the public of a pesticide drift incident. This can be, but is not limited to, notification of affected residents, and identification of a safe refuge area if required. For the purposes of this subject, a safe refuge area is an area where further pesticide exposure via inhalation or dermal contact shall not occur.

#### 6.6.2 Informing the Public of HAZMAT Properties

Once assessment of the material is complete, the Information Officer will work with the Hazardous Materials Group and Environmental Group to develop information releases to agencies, media, and public. Training and exercises for Information Officers will incorporate State guidance for Risk Communications at Hazardous Materials scenes.<sup>35/</sup>

#### 6.6.3 Release Scenarios

An ICS structure for response agencies has been developed to manage incidents ranging from most-likely scenarios to Pesticide Drift to Weapons of Mass Destruction incidents. These cover biological and technological HAZMAT scenarios.<sup>36/</sup> Implementation of this structure is the fundamental method for ensuring public and responder safety. The “Hazardous Materials Responsibility Matrix” shows agency responsibilities for performing these functions and is an attachment to this section.

#### 6.6.4 Preplanning Properties for Protective Actions

Part of ongoing Risk Management Program (RMP) planning is to assess impact of releases in a worse case scenario to schools, businesses, and residential areas. Businesses must develop release plumes, health risks, and quantities based on historical climate data, terrain surrounding facility, and population. The Hazardous Material Management Program (HMMP) requires businesses to develop diagrams and characteristics of a facility.

---

<sup>35</sup> Annex G: Media and Public Information Functions for Hazardous Materials in California, State of California, March 1995.

<sup>36</sup> ICS organizational charts (ICS Form 209) have been included in Attachment #6 “Response Levels.”



#### 6.6.5 Safe Route of Approach

Appropriate and safe routes of approach and other vital information will be provided to dispatch by the first public safety responders on-scene. This allows dispatch to identify the safe approach route for subsequent responders.

### 6.7 **Medical Resources**

Emergency medical responders will become a part of any large incident to provide medical support for hazardous materials team operations. The San Joaquin County Multi-Casualty Incident (MCI) system is integrated into the hazardous materials ICS structure to provide medical support to victims.

### 6.8 **Mass Care Shelter**

The American Red Cross, supported by the County, will open and operate Mass Care Shelters. Reception Care Centers will be established to help evacuees identifying their specific needs. The American Red Cross will establish a database for handling disaster welfare inquiries from the public.

School districts are required to allow the use of school buildings, grounds, and equipment to public agencies, including the American Red Cross, for mass care and welfare shelters during disasters or other emergencies. These centers are often at high schools or other facilities where the Red Cross has standing agreements.<sup>37/</sup>

#### 6.8.1 Shelter Operations Agency

During small events, the Incident Commander's jurisdiction is responsible for activating a Care and Shelter within their emergency organization.<sup>38/</sup> Any costs are the responsibility of the Command since the agencies of jurisdictions receiving evacuees are considered a "cooperating agency" under the Incident Command System. The Incident Command Information Officer will work with all impacted jurisdictions to establish some type of information center or process, which will allow evacuees to track the status of the evacuation.

If there are multiple jurisdictional needs or a large event is occurring, requests for shelters and disaster relief will be forwarded to the Operational Area Care and Shelter Branch Manager. The Operational Area Care and Shelter Manager will be responsible for

---

<sup>37</sup> §38132, Article 2, Chapter 4, Part 23, Division 3, Title 2, Education Code

<sup>38</sup> This is similar to the Logistics Section "Camp Manager" position. The position should be under Logistics. If an EOC is open, then the position could operate from there. Most jurisdictions have appointed the local Red Cross chapter to run shelters and this position; some use their Parks & Recreation to coordinate shelter locations and ARC to run them.

coordinating relief requests and may develop an overall shelter plan. Local jurisdictions coordinate with, and assist shelter managers operating mass care facilities in their jurisdiction. Such action is covered in the overall Care and Shelter plan developed at the Operational Area level.

#### 6.8.2 Local Shelter Non-Profit Agencies

The local San Joaquin Chapter of the American Red Cross assists the Care and Shelter Branch in the Operational Area Emergency Operations Center. This non-profit agency will operate shelter programs under the overall Care and Shelter Plan. They also maintain a database of facilities that have a written agreement to host a shelter. All facilities should have accommodations for sanitation, cooking, and sleeping ability for large groups.

The Disaster Relief Coalition will assist the Operational Area EOC Care and Shelter Branch. This coalition has assisted in some special sheltering situations and in donation management.

#### 6.8.3 Animal Sheltering

Several animal rescue and assistance agencies offer to care and shelter pets and livestock during an evacuation. The American Red Cross, Salvation Army, and most shelter agencies do not care for animals. The countywide government animal control agencies have developed an animal control mutual aid plan for coordinating assistance for each other. Plans for opening shelter complexes in large incidents involving large numbers of evacuees have provisions for pet and animal management.

#### 6.8.4 Disaster Welfare Inquiries

The San Joaquin Operational Area may activate a disaster welfare inquiry function to collect and distribute information on victims who were transported to medical facilities. Information is collected from hospitals and other medical facilities and provided to persons seeking information on individuals as well as to emergency responders with a need to know.

The local American Red Cross, along with the Mental Health Services will staff the Disaster Welfare Inquiry Team. This team shall operate in the Operational Area Emergency Operations Center. Disaster Welfare Inquiries for individuals who may be in shelters or who are otherwise unaccounted for, will be directed to the American Red Cross, San Joaquin Chapter, for processing under their standard procedures. Information on deceased persons will not be released but inquiries will be discretely forwarded to the Coroner's Office.

### 6.9 **Incident Recovery Operations**

The Incident Commander must consult with the Incident Safety Officer and the County Health Officer prior to terminating any declarations or proclamations for the incident. Once this is accomplished, the Environmental Health Division and other Public Health officials will work with appropriate agencies on a plan for clearing impacted areas for reoccupation. Incident command will transfer during this phase to the Environmental Health Division and an ICS staff structure will be retained to assist in the planning and implementation process.

#### 6.9.1 Disaster Recovery Plan

An evacuation area pass system was developed to control flow of people and vehicles into an area. This plan allows initial recovery agencies to prepare the area, control criminal activity, and for critical business activities to resume as soon as possible. Once an area has been deemed safe for entry residents may be allowed in on a limited pass, if the area has not already been determined ready for normal activities.

**SECTION 7: SUPPLIES AND EQUIPMENT**  
(§2727 H&S, §5000 USC)

**7.1 Agency Responders**

**7.1.1 Fire and Medical**

City and rural fire departments are equipped to the level that meets the needs of their jurisdictions. Large city departments have more resources than smaller jurisdictions. The City of Stockton Fire Department is rated as a Class I Fire Department and is the best staffed of all fire departments in the San Joaquin Operational Area.

Under Mutual Aid Agreements both City and special district jurisdictions can manage most incidents without requesting assistance at the Region IV or State level. Stockton and Lodi City Fire Departments have dedicated Hazardous Materials Response Units and can handle most of their routine hazardous material incidents.

**7.1.2 Hazardous Materials Teams**

The Operational Area has four (4) hazardous material response vehicles. These are with the Stockton City Fire Department, Lodi City Fire Department, Tracy Fire Department and San Joaquin County Office of Emergency Services respectively. Hazardous materials technicians and specialists are supplied by daily shift personnel for the fire departments that are signatory to the Joint Hazardous Materials Team Agreement and the six on-call hazardous material specialists in the Office of Emergency Services.

Personnel and equipment call-out is performed under procedures contained in the San Joaquin Joint Hazardous Materials Team Policies and Procedures Manual. There are currently over 50 individuals in the Operational Area trained to these levels and can respond.

Each hazardous materials response unit carries chemical protective suits, respiratory protective equipment, testing equipment, containment equipment, support gear, and communications equipment. There is also a network of support vehicles and equipment with fire departments that have entered with the agreement to become part of the joint team.

Other equipment available includes a trailer mounted mass decontamination tent and several mobile command posts. Any or all of this equipment is available for an incident if the need arises. For further reference, the Office of Emergency Services maintains a list of resources in countywide response vehicles.

#### 7.1.3 Public Works/Municipal Utilities

County and City Public Works, and Municipal Utility Departments in the Operational Area can assist hazardous materials operations by shutting down water lines, closing storm drains and sewer lines. They are also a resource for heavy equipment, sand/absorbent, and drainage materials to use on defensive operations such as diking large spills. During evacuations or area closures, these agencies provide barricades, electronic directional signs, and road signs.

#### 7.1.4 Local Public Health Agencies and County Agricultural Commissioner's Office

Agencies specializing in health matters can be important when dealing with releases of hazardous materials. Symptoms of exposure, toxicology, and assistance with the Care and Shelter Branch can be addressed by Public Health specialists. The County Agricultural Commissioner's Office (CAC) can assist with issues regarding Pesticide Drift. California State law<sup>39</sup> requires the CAC to enforce pesticide drift regulations within the county. The CAC is the subject matter experts in assisting an Incident Commander with proper guidance and information during a pesticide emergency within the Operational Area.

#### 7.1.5 Law Enforcement Agencies

Area law enforcement agencies have formed a San Joaquin Metropolitan Bomb Team, which includes several agencies outside of the Operational Area. Training includes the wearing of Level B protective equipment for working in contaminated environments. In addition, a bomb robot is available for response to potentially explosive devices.

### **7.2 Emergency Operations Center (EOC)**

The Operational Area EOC for San Joaquin County is in the Robert J. Cabral Agricultural Center in South Stockton, adjacent to the Stockton Metropolitan Airport. This facility maintains telephone banks, radios, computers, and stationary, fax machines for supporting Operational Area functions. The Emergency Operations Center is divided into planning/intelligence, incident management, logistics, and finance/administration functions and contains several separate

---

<sup>39</sup> California Food and Agricultural Code 12977

briefing/conference rooms. Procedural binders and documents are available in the center for managing all aspects of this operation.

#### 7.2.1 City Emergency Operations Centers

All the cities in the Operational Area have designated a facility to serve as their Emergency Operations Center. These facilities have been tested during exercises or actual events. The Operational Area periodically exercises with one or more of the cities to test coordinating procedures between Emergency Operations Centers.

Only the County Sheriff has a dedicated Department Operations Center (DOC) to support specific law enforcement incidents. The Sheriff is the designated law enforcement mutual aid coordinator. The Operational Area has selected the Sheriff headquarters facility as an alternate Emergency Operations Center. This is in a separate area than their DOC.

#### 7.2.2 Access to Equipment

All the jurisdictions within the operational area may be contacted on a 24-hour basis by use of the pre-established mutual aid coordination and communications systems. In most cases this will involve contacting the Office of Emergency Services Hazardous Materials Duty Officer who can then either contact the required agency directly or through the San Joaquin County Sheriff Dispatch Center.

### **7.3 Emergency Response Capabilities**

Throughout the Operational Area, agencies have designated locations and facilities to be utilized by any public safety discipline for an emergency response. Combined with the types of equipment available as described in the previous section, emergency response capabilities are identified as follows:

#### 7.3.1 Mobilization Centers

This type of facility is for resources assigned to the Operational Area, or a nearby event, but has not been dispersed to a specific incident.

#### 7.3.2 Staging Areas

A Staging Area is defined as a facility for temporarily locating resources. These resources must be ready to respond within three (3) minutes. There are no pre-designated Staging Areas in the Operational Area.

### 7.3.3 Rendezvous Points

These sites are for quick assembly of resources prior to driving to an incident. Though originally developed for “out of county” responses, these sites are also suited for “in county” responses.

### 7.3.4 Casualty Collection Points/Field Treatment Sites

Casualty Collection Points (CCP) are established to receive or disperse casualties into or out of San Joaquin County. Field Treatment Sites (FTS) are to triage, stabilize, or treat casualties to be dispersed to area hospitals. The primary centralized location for both within the Operational Area is the Stockton Metropolitan Airport. This serves both as a CCP or a FTS. The Airport is capable of landing and take-offs of the largest military aircraft.

## 7.4 **San Joaquin County Emergency Resources**

### 7.4.1 Private Sector

The San Joaquin County Department of Purchasing and Support Services maintain a comprehensive resource directory. The directory contains an alpha listing of vendors for supplies and equipment. Some vendor contacts are maintained on the Operational Area (internet) web site for public use in obtaining disaster supplies (e.g., sand, sandbags, survival supplies, and emergency radios).

### 7.4.2 Public Sector

The Office of Emergency Services maintains a computer database directory with contacts for local, State, and federal agencies. This directory is available on a 24-hour basis. The various mutual aid coordinators keep agency contacts for their specific discipline. If a resource request does not fall within an established mutual aid system, the Operational Area Logistics Section has access to this resource list to locate the appropriate agency that can provide the resource.

See Communications Plan



**SECTION 8: INCIDENT CRITIQUE AND FOLLOW-UP**  
(§2728 H&S, §4570 UCS)

**8.1 Post Incident Analysis for Routine Incidents in the San Joaquin Operational Area**

Routine incidents in the Operational Area responders will follow the guidelines in Section 21 of the Joint Hazardous Materials Response Team Policies and Procedures Manual under Incident Critique. See Appendix 12. Critiques usually follow incident termination when all responders are present and the incident events are quickly recalled. In large or long-term incidents such critiques are not always feasible or practical. In these situations, the Hazardous Materials Group Supervisor will need to schedule a time and meeting place to conduct a critique. These should be within 72 hours of the incident termination while memories of events are still fresh.

Critiques from major disasters are scheduled sometime after the incident. These incidents require a significant recovery period to restore normal activities, and many responders are too involved to attend. Critiques are often difficult to employ. However, some post incident analysis is required by SEMS law and usually conducted with 10 days of demobilization of the event. A common practice for such events is conducting some type of brief critique during the daily action plan meeting, but not supersede an in depth analysis.

**8.2 Community Critiques**

A debriefing or public comment session had, in the past, helped response agencies and the community understand what, why, how certain events or actions happened. Though it can be difficult or stressful, this is very beneficial to learn how to advise or interact with the community. The recovery steps can be the most expensive and emotionally trying for all involved.

Emergency and recovery plans should be reviewed and revised based on the issues brought up in the agency and community reviews. Also, enhancing warning systems should be considered to fill shortfalls.

**SECTION 9: SECTION 25503 (E) INFORMATION**  
(§25503 H&S)

**9.1 Business Hazardous Materials Disclosure Information**

San Joaquin County Office of Emergency Services is the Administering Agency (AA) for the carrying out of Chapter 6.95.<sup>40/</sup> Approximately 2,000 businesses are currently maintained on the system with business information and chemical inventories.

**9.2 Data Management System**

The data management system for the County's business plans is a relational database (File Maker Pro) supported by an Apple Macintosh system. Both the business plan requirements,<sup>41/</sup> and the Risk Management Program requirements are contained in the database.<sup>42/</sup> The program is very flexible by allowing the user to print predetermined scripts for most commonly requested information or allowing programming for specific report information. General information for public disclosure and distribution is under the pre-program scripts.

Electronic transfer of information has greatly enhanced the efficiency and productivity of the department. Again information on business plans can be distributed electronically via E-mail or printed on hard copy for walk-in requests or mailing.

Public safety agencies with proper passwords can download Hazardous Materials Management Plan data from a web site established by the Office of Emergency Services as of October 2000. Agencies can also receive the information by coming to the office and downloading the data onto portable hard drives or zip drives.

The hazardous materials response vehicle computer is updated weekly with all business plan files, the Emergency Telephone Directory, and past hazardous materials incident reports. Consequently, all business plans and chemical inventory information are directly available to responders upon the arrival of the Office of Emergency Services vehicle.

---

<sup>40</sup> §Article 1 & 2, Chapter 6.95, Division 20, Health and Safety Code

<sup>41</sup> §25503, Article 1, Chapter 6.95, Division 20, Health and Safety Code

<sup>42</sup> §25531 Article 2, Chapter 6.95, Division 20, Health and Safety Code

**SECTION 10: LOCAL RESOURCE INFORMATION**  
(§9973 UCS)

**10.1 Identification of Natural Resources and Local Conditions**

10.1.1 Significant Natural Resource Areas

The most environmentally sensitive areas of San Joaquin County include the areas in proximity to the Stanislaus, Calaveras, San Joaquin, and Mokelumne Rivers and their tributaries as well as the legally defined Sacramento-San Joaquin Delta. All agencies take additional precautions for incidents that occur in sensitive areas because of the inherent mobility potential for spills in waterways and the subsequent widespread threat to wildlife and water supplies.

Various locations within the county are also the habitat of approximately 97 endangered species. Most notable are riverside, or riparian, species such as the San Joaquin Riparian Brush Rabbit and the Riparian Wood rat. The county is also the habitat of the San Joaquin County Kit Fox. In situations where an endangered species may be encountered, the Incident Command shall work with the County Environmental Health Department, the California State Department of Fish and Game, the California Department of the Interior, and the U. S. Fish and Wildlife Service for further information and species protection.

10.1.2 Structures Located in Marine Waters

The Port of Stockton is the major maritime facility within the county. The Port encompasses a variety of functions from fuel storage and blending facilities, storage of bulk dry and liquid hazardous materials to loading and offloading hazardous materials from vessels. Over 3.2 million metric tons of cargo was received at the Port in 2006. Included in this cargo were cement, fertilizers, and anhydrous ammonia. In case of an emergency involving the Port, the Port of Stockton Police Department is the Incident Commander. They shall work with Port of Stockton authorities and the Responsible Party involved. In recent years, the Port Authority has extended to the decommissioned naval base of Rough and Ready Island. This facility now houses a wide array of distribution centers and storage areas posing further hazardous materials risk.

Other structures throughout the county include private marinas, marinas with fuel docks, boatyards, and public boat ramps. On river and delta waters, jurisdictional responsibility for hazardous materials releases, including oil, may be either the California Fish and Game Oil Spill and Pollution Response (OSPR) or the United States Coast Guard Sector San Francisco. County resources may be called in to assist with initial assessment, site control or deployment of resources such as sorbent pads and boom.

### 10.1.3 Areas Where Spills are Most Likely to Occur

Spills are most likely to occur when hazardous materials are in transit or being transferred from one mode of transportation or storage to another. In most situations, spills will be minor and are competently handled by on-scene personnel. The most common scenario for such types of spills are concentrations of industry involving hazardous materials such as the Port of Stockton and major transportation arteries such as Interstate 5 and Highway 99. Transportation risk is also present in other modes of transport throughout the county as found in pipeline systems, rail networks and Stockton Metropolitan Airport.

## 10.2 **Identification of Facilities and Local Areas of Concern to Local Government**

### 10.2.1 Facility Prioritization

There is no set prioritization of facilities identified for resumption of normal activities. However, in the case of a large-scale disaster such as an earthquake, prioritization will be given to critical service entities such as hospitals and other such emergency care facilities. Service infrastructure such as major highways and bridges will also be of high concern due to the needs placed on such structures during an emergency.

### 10.2.2 Economic Resources Prioritization

Prioritization shall be given to the East and West Complexes of the Port of Stockton. Further determination of prioritization will be made using the FileMakerPro Critical Facilities Database maintained by the San Joaquin County Office of Emergency Services.

### 10.2.3 Significant Areas Requiring Closure or Protective Measures

#### 10.2.3.1 River systems within San Joaquin County

San Joaquin County is crossed by a myriad of rivers and associated tributaries that feed into the San Joaquin/Sacramento Delta. These rivers run through the county from the south, east and to a limited degree from the north. The rivers end in the Delta system and significantly add to the water budget. While passing through the county, many of the rivers cross major transportation routes such as Highway 99 and Interstate 5. There have been situations where hazardous materials incidents on the roads have impacted nearby rivers and created a more significant response. It shall be the responsibility of the Incident Commander to recognize the potential threat to rivers and other waterways when determining proper response. Further information on waterways, environmentally

sensitive areas and emergency response on the waterways can be found in the San Francisco Bay and Delta section of the United States Coast Guard Area Contingency Plan. See Attachment 4 (12.5.7 – Section 7000).

#### 10.2.3.2 The San Joaquin Delta

Due to the variety in uses found in the Delta region, this area may require special protective measures. The Delta is used as a water resource for irrigation and canal systems. In addition it is a fragile marine ecosystem and migratory bird refuge. The Delta also is a marine transit route for vessel traffic to and from the Port of Stockton. Several pipeline systems transit the Delta as well as major roads.

#### 10.2.3.3 Jurisdictional Response to Hazardous Materials releases in the Delta

If a hazardous materials incident occurs on a highway through the Delta, Incident Command will be the responsibility of the California Highway Patrol (CHP). The Incident Commander will ensure proper notification is made to the California Office of Emergency Services. This office will inform other agencies of an incident that may spread beyond the scene of the incident and have an adverse impact on the surrounding ecosystem. Emergency service response teams will follow closely the guidance of the CHP when approaching an incident scene. In many locations such as Highway 12 through the Delta, heavy traffic and narrow roads can pose a high level of traffic accident risk.

Hazardous materials entering the waterways of the Delta may require multi-agency response due to the potential of significant environmental impact and further spread/transport of the contaminant. Incident Command may initially reside with the local response agency, but can switch to the State or federal level if significant resources and specialized response is required. At the State level, the California Department of Fish and Game is designated as the State Agency Coordinator. This agency shall work with all involved parties and local government and take part in the Unified Command structure as appropriate.

At the federal level, responsibility for control, monitoring or oversight shall be the responsibility of the United States Coast Guard or United States Environmental Protection Agency, depending on the location, extent and potential path of the discharge. The general pattern is to keep response at the local or state level as much as possible. However, the federal agencies are able to bring a large range of specialized response equipment and specially trained personnel that may not be available at the local level.

If the closure of the Stockton Ship Channel to vessel traffic is required, the Commanding Officer of the U. S. Coast Guard Sector San Francisco shall issue a "Broadcast Notice to Mariners." The procedures for this can be determined by contacting Sector San Francisco at (415) 399-3547. Local closure of rivers, navigable canals, and boating recreational areas can be authorized at the state level as long as there

is no interference with commerce. Local resources such as the San Joaquin County Sheriff's office can assist with waterway closure.

#### 10.2.3.4 Recreational Areas

The Operational Area encompasses a wide array of recreational areas. These range from parks established to protect endangered species, smaller residential neighborhood parks and large-scale marinas in the Delta. The Incident Commander shall work with local agencies such as law enforcement and the County Environmental Health Department to ensure localized and specialized concerns are met. A hazardous materials release in a recreational area may require specialized zone control and interaction with Risk Communications to ensure proper evacuation/closure reports are made.

## LIST OF AUTHORITIES

### Local Ordinance or Policy

Motor Vehicle Accident Spill Policy, County of San Joaquin Toxic Enforcement Strike Force

### California Codes and Regulations

§25500, Article 1, Chapter 6.95, Division 20, Health and Safety Code

§25403, Article 1, Chapter 6.95, Division 20, Health and Safety Code

§25404.1(b)(1), Chapter 6.11, Division 20, Health and Safety Code

§25185, Article 1, Chapter 6.95, Division 20, Health and Safety Code

§25507, Article 1, Chapter 6.95, Division 20, Health and Safety Code

§25508, Article 1, Chapter 6.95, Division 20, Health and Safety Code

§25531, Article 1, Chapter 6.95, Division 20, Health and Safety Code

§101085, Article 2, Chapter 2, Part 3, Division 101, Health and Safety Code

§120175, Chapter 3, Part 1, Division 101, Health and Safety Code

§2501, Article 1, Chapter 4, Division 1, Title 17, Code of Regulations

§2720, Article 3, Chapter 2, Title 19, California Code of Regulations

§852.60-852.65,

§852.62.2, Article 2, Chapter 5, Subdivision 4, Division 1, Title 14, Code of Regulations

§2735.1, Article 1, Chapter 4.5, Division 2, Title 19, California Code of Regulations

§5192(q)(6), Article 109, Chapter 4, Division 1, Title 8, California Code of Regulations<sup>6</sup>

§5192(q)(3)(a), Article 109, Chapter 4, Division 1, Title 8, California Code of Regulations

§5192(l)(6) and (7), Article 109, Chapter 4, Division 1, Title 8, California Code of Regulations

§38132, Article 2, Chapter 4, Part 23, Division 3, Title 2, Education Code

§409.5, Title 11, Part 1, California Penal Code

Natural Disaster Assistance Act, as amended: §8680 through 8692, Article 1-5, Chapter 7.5, Division 1, Title 2, California Government Code

§8607, Article 9.5, Chapter 7, Division 2, Title 2, California Government Code

FIRESCOPE Incident Command System (ICS) Module HM 120-1. Section IV

Federal Codes and Regulations

29 CFR 1910.120

29 CFR 1910.120(q)(6)

29 CFR 1910.120(q)(11)

29 CFR 1910.120(l)(1)(i)

29 CFR 1910.120(p)(8)(i)

29 CFR 1910.120(q)(3)(i)

Robert T. Stafford Disaster Relief and Emergency Act, Public Law 93-288, as amended.

Title 44, Code of Federal Regulations, Part 206



## **SECTION 11: ATTACHMENTS**

**11.1 Organizational Charts**

**11.2 Incident Command Authority**

**11.3 Jurisdictional/agency Roles and Responsibilities**

**11.4 USCG-EPA Boundary map**

**11.5 Training Table**

**11.6 Health Officer Authority**

**11.7 Vacant**

**11.8 Vacant**

**11.9 Vacant**

**11.10 Notification Procedures**

**11.11 Vacant**

**11.12 Radio Systems**

## **SECTION 12: APPENDIX**

Appendices are separate documents required, or preferred, to be a “stand-alone’ document. Some of these have a separate checklist for completion compliance.

**12.1 Vacant**

**12.2 Vacant**

**12.3 Response Levels**

**12.4 Position Checklists**

**12.5 Response Policies**

**12.6 Clean Up Policies**

**12.7 Vacant**

**12.8 Vacant**

**12.9 Hospital Hazardous Materials Guidelines**

**12.10 Deployment of Mass Decontamination Systems**

**12.11 Oil Spill Procedures San Joaquin**

**12.12 Joint Hazardous Materials Response Team - Policies and Procedure**

HAZARDOUS MATERIALS  
ICS-207 Chart  
GENERAL HAZARDOUS MATERIALS

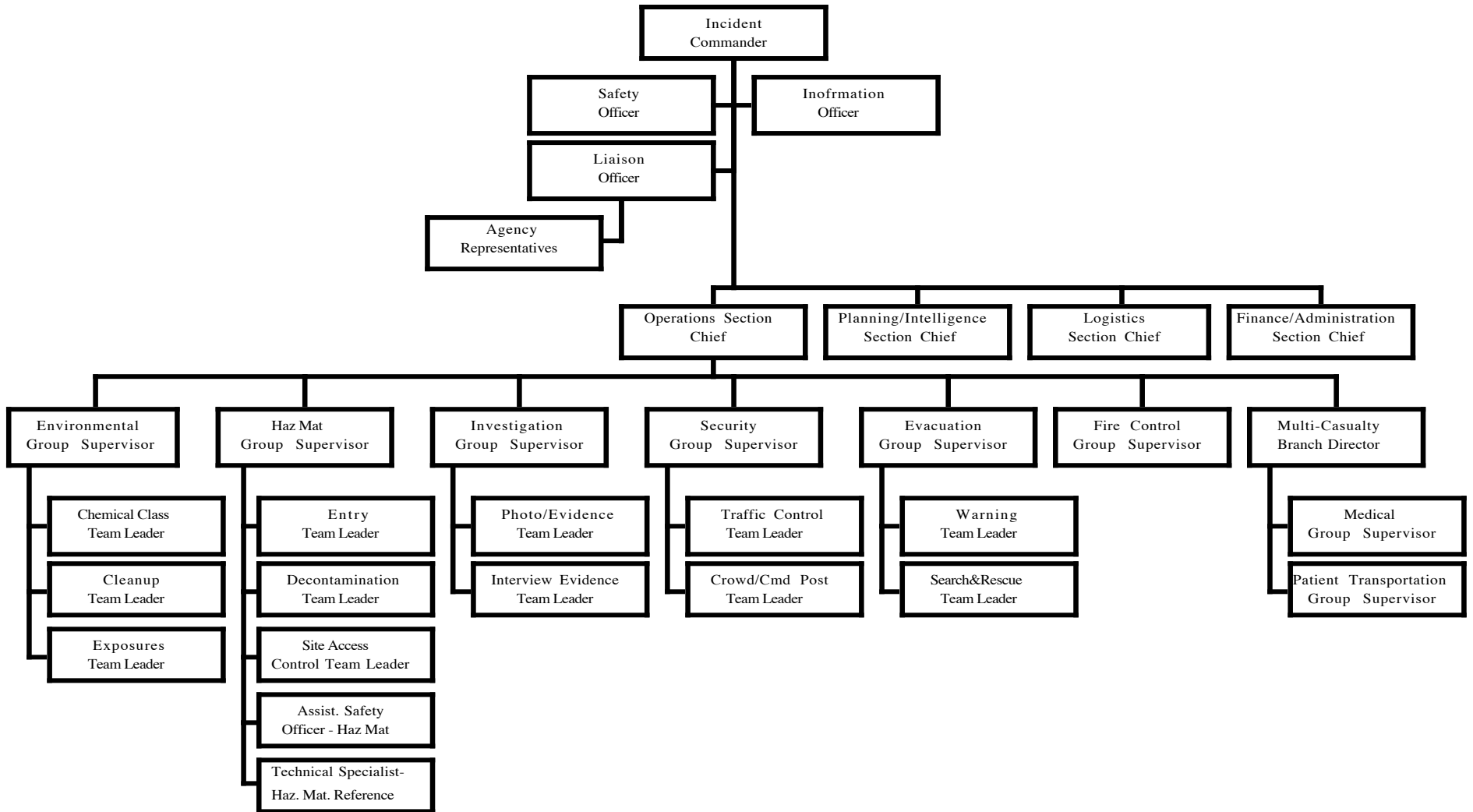

# HAZARDOUS MATERIALS ICS-207 Chart

## Weapons of Mass Destruction Incident - Non-Biological Threat

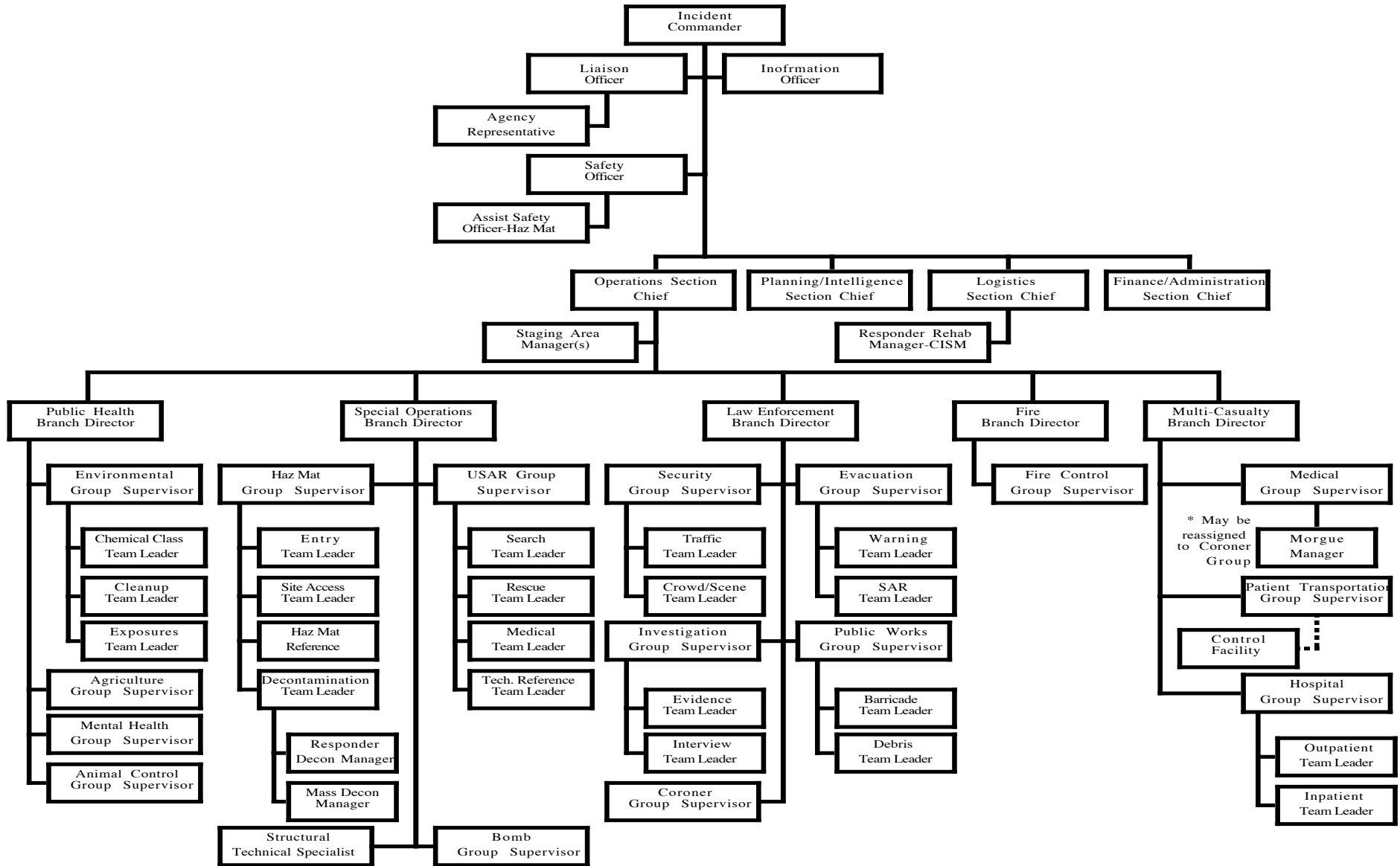

# HAZARDOUS MATERIALS ICS-207 Chart

Weapons of Mass Destruction Incident - Biological Threat

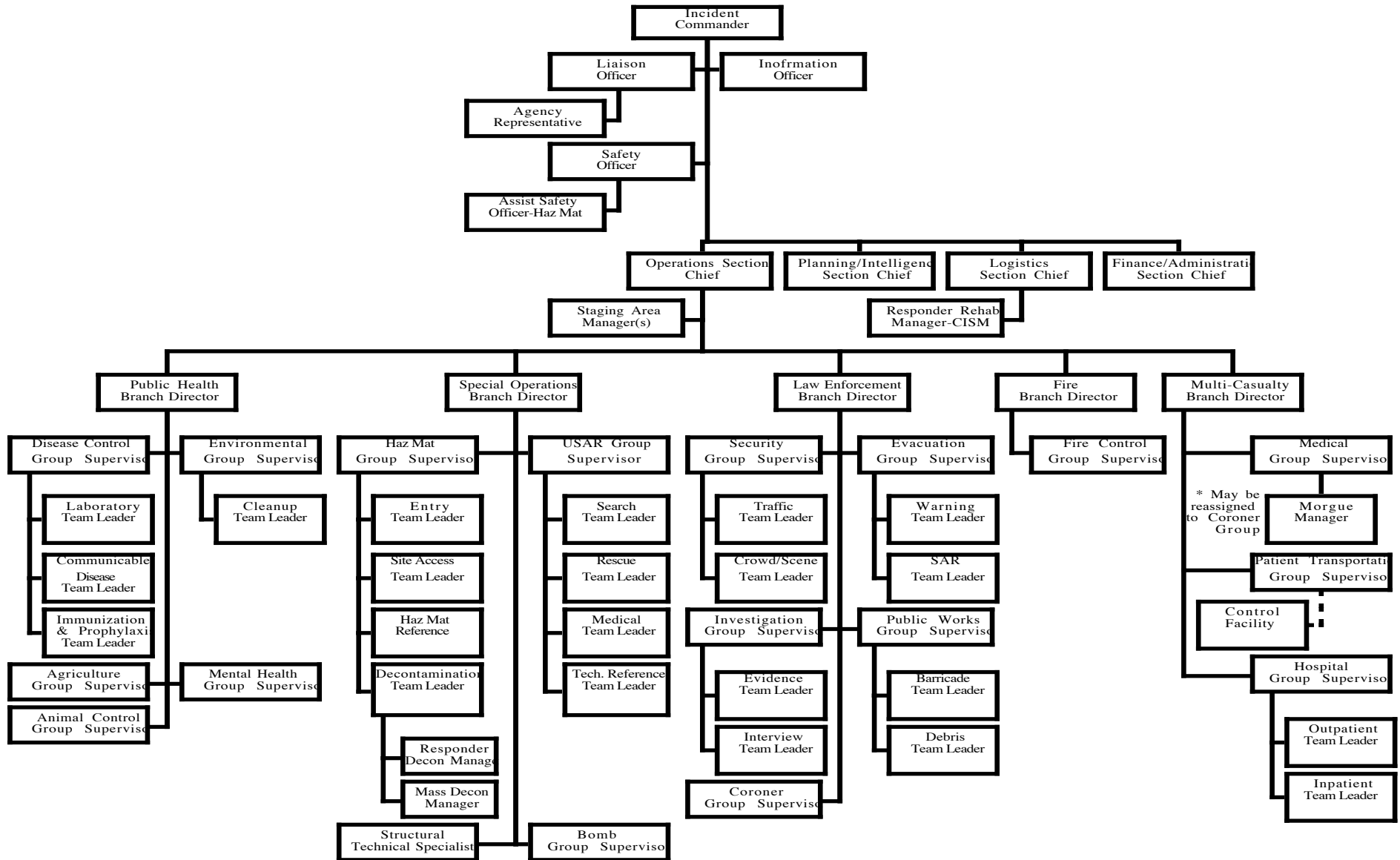

**INCIDENT COMMAND AUTHORITY**  
**Hazardous Material**  
 [29 CFR Part 1910.120, 5192 CCR]

AGENCY COORDINATION	
State Agency Coordinator (SAC) State Operating Authority	<ul style="list-style-type: none"> <li>• CHP - on highway [MOU with State OES 11-2-82]</li> <li>• F&amp;G- off highway [MOU with State OES 11-2-82]</li> </ul>
Federal On Scene Coordinator (FOSC)	<ul style="list-style-type: none"> <li>• EPS/USCG- dependent on boundary (see attachment)                             <ul style="list-style-type: none"> <li>- 40 CFR 300.120</li> <li>- USCG Central &amp; Northern California Coastal Zone, Oil &amp; Hazardous Substance Federal Pollution Contingency Plan, Annex I (1103) – I-2</li> </ul> </li> <li>• DOD – If on a DOD facility or agency involved property</li> <li>• DOE – If DOE licensed property</li> <li>• FBI – Terrorism events</li> </ul>

INCIDENT	IC AGENCY	AUTHORITY
<b>GENERIC EMERGENCY SCENE - Any site</b> (If not specified below)	<ul style="list-style-type: none"> <li>• Public safety agency having primary investigative authority</li> </ul>	<ul style="list-style-type: none"> <li>• Health &amp; Safety Code §1798.6 (a)</li> </ul>
<b>PRIVATE SECTOR</b>	<ul style="list-style-type: none"> <li>• Business employer</li> </ul>	<ul style="list-style-type: none"> <li>• CCR Title 8 Div.1 §5192 (q)(3)(i)</li> <li>• 29CFR1910.120 (q)(3)(ii)</li> </ul>
<b>ON-HIGHWAY</b>		
<ul style="list-style-type: none"> <li>• Freeways</li> <li>• Incorporated</li> <li>• local streets</li> <li>• local roads</li> </ul>	<ul style="list-style-type: none"> <li>• CHP (also State Agency Coordinator)</li> <li>• Local law enforcement agency (if no MOU approved with another public agency)</li> <li>• Stockton Fire Department</li> <li>• County Health Officer</li> <li>• CHP</li> </ul>	<ul style="list-style-type: none"> <li>• §2454 CVC</li> <li>• §8574.17 CGC</li> <li>• §409.3 PC (accidents in general)</li> <li>• MOU with Stockton Police (3-29-89)</li> <li>• §101040 H&amp;S</li> </ul>
<ul style="list-style-type: none"> <li>• Unincorporated</li> </ul>	<ul style="list-style-type: none"> <li>• CHP</li> <li>• County Health Officer</li> </ul>	<ul style="list-style-type: none"> <li>• §2454 CVC</li> <li>• §409.3 PC</li> <li>• §8574.17 CGC</li> <li>• §101040 H&amp;S</li> </ul>
<b>OFF-HIGHWAY</b>		
<ul style="list-style-type: none"> <li>• Incorporated</li> </ul>	<ul style="list-style-type: none"> <li>• Local Government designated (fire, law, health, etc.)</li> <li>• Public agency facility operator (water treatment or utility, motor pool, etc.)</li> <li>• Stockton Fire</li> <li>• County Health Officer</li> </ul>	<ul style="list-style-type: none"> <li>• Plans, Agreements and Ordinances</li> <li>• §409.3 PC (accidents in general)</li> <li>• Jurisdiction</li> <li>• MOU with Stockton Police (3-29-89)</li> <li>• §101040 H&amp;S</li> </ul>
<ul style="list-style-type: none"> <li>• Unincorporated</li> </ul>	<ul style="list-style-type: none"> <li>• S.J. County Sheriff</li> <li>• Public agency facility operator (see above)</li> <li>• County Health Officer</li> </ul>	<ul style="list-style-type: none"> <li>• Sheriff General Order #E-8</li> <li>• Jurisdiction</li> <li>• §101040 H&amp;S</li> </ul>
<ul style="list-style-type: none"> <li>• Oil spills</li> </ul>	<ul style="list-style-type: none"> <li>• Local Government policy</li> </ul>	<ul style="list-style-type: none"> <li>• CA Oil Spill Contingency Plan (1983), p. 12</li> </ul>
<ul style="list-style-type: none"> <li>• Not in “marine waters”</li> </ul>	<ul style="list-style-type: none"> <li>• Local Incident Commander serves until relieved by the SAC or a federal On-Scene</li> </ul>	<ul style="list-style-type: none"> <li>• CA Oil Spill Contingency Plan (1983), p. 21</li> </ul>

<b>Pipeline</b>	<ul style="list-style-type: none"> <li>Calif. Dept. of Forestry (CDF)</li> </ul>	<ul style="list-style-type: none"> <li>State Haz Mat Plan</li> </ul>
<b>WATERWAYS</b>	<ul style="list-style-type: none"> <li>?</li> </ul>	<ul style="list-style-type: none"> <li>?</li> </ul>
<ul style="list-style-type: none"> <li>Waters Of State</li> </ul>		
<ul style="list-style-type: none"> <li>Marine Waters</li> </ul>	<ul style="list-style-type: none"> <li>U.S.C.G.</li> <li>Responsible Party (as part of an Unified Command)</li> </ul>	<ul style="list-style-type: none"> <li>§311(c), Clean Water Act, 33 U.S.C. 1321</li> <li>§311(c), Clean Water Act</li> <li>40 CFR 300), National Contingency Plan</li> <li>Federal Response Plan, ESF #10-2. A.3</li> </ul>
<p><b>Oil Spills</b></p> <ul style="list-style-type: none"> <li>&lt;42 gal</li> </ul>	<ul style="list-style-type: none"> <li>U.S.C.G.</li> </ul>	<ul style="list-style-type: none"> <li>S.F. Oil Spill Prevention and Response Plan, Tab E-1</li> <li>Oil &amp; Hazardous Substance Federal Pollution Contingency Plan, 202</li> </ul>
<ul style="list-style-type: none"> <li>≥42 gal</li> </ul>	<ul style="list-style-type: none"> <li>U.S.C.G.</li> <li>California Fish &amp; Game (OSPR)</li> </ul>	<ul style="list-style-type: none"> <li>§311(c), Clean Water Act</li> </ul>
<ul style="list-style-type: none"> <li>Spill Of National Significance (SONS)</li> </ul>	<ul style="list-style-type: none"> <li>U.S.C.G./EPA (dependent on Fed Agency Coord. boundary)</li> </ul>	<ul style="list-style-type: none"> <li>CGC §8670.7</li> <li>U.S.C.G. Bay &amp; Delta Oil Spill Contingency Plan (PP. A-V-1, 2,23-24)</li> </ul>
<b>RADIOLOGICAL</b>		<ul style="list-style-type: none"> <li>Calif. State Emergency Plan-Terrorism Annex</li> </ul>
<ul style="list-style-type: none"> <li>Shipment licensed by NRC</li> </ul>	<ul style="list-style-type: none"> <li>NRC</li> </ul>	
<ul style="list-style-type: none"> <li>Shipment by DOE or DOD</li> </ul>	<ul style="list-style-type: none"> <li>DOE or DOD</li> </ul>	
<ul style="list-style-type: none"> <li>Shipment not licensed or owned by NRC</li> </ul>	<ul style="list-style-type: none"> <li>EPA</li> </ul>	
<ul style="list-style-type: none"> <li>Other emergencies</li> </ul>	<ul style="list-style-type: none"> <li>Confer between local, state Health, EPA</li> </ul>	
<b>AIRCRAFT</b>	NTSB	<ul style="list-style-type: none"> <li>49 USC 190</li> </ul>
<ul style="list-style-type: none"> <li>Incorporated/off-highway</li> </ul>	NTSB	<ul style="list-style-type: none"> <li>49 USC 190</li> <li>49 CFR 830.10 (b)</li> <li>49 CFR 831.10 (a)(b)</li> </ul>
<b>WEAPON OF MASS DESTRUCTION</b>		
<b>Crisis Management</b>	<ul style="list-style-type: none"> <li>FBI (also overall Lead Federal Agency)</li> </ul>	<ul style="list-style-type: none"> <li>Presidential Decision Directive 39 (PDD-39)</li> <li>Federal Response Plan – TI-1</li> <li>Calif. State Emergency Plan-Terrorism Annex</li> </ul>
<ul style="list-style-type: none"> <li>Prevent, preempt, and terminate threats or acts of terrorism</li> </ul>		
<ul style="list-style-type: none"> <li>Apprehend and prosecute perpetrators</li> </ul>		
<b>Consequence Management</b>		<ul style="list-style-type: none"> <li>Presidential Decision Directive 39 (PDD-39)</li> <li>Federal Response Plan – TI-1</li> <li>Calif. State Emergency Plan-Terrorism Annex</li> </ul>
<ul style="list-style-type: none"> <li>Protect public health &amp; safety</li> </ul>		
<ul style="list-style-type: none"> <li>Provide emergency relief to governments, businesses, and individuals</li> </ul>		
<ul style="list-style-type: none"> <li>Restore essential government services</li> </ul>		
<ul style="list-style-type: none"> <li>City &amp; Unincorporated</li> </ul>	<ul style="list-style-type: none"> <li>Local Policy – Non-biological</li> <li>Public Health Officer – biological event</li> </ul>	<ul style="list-style-type: none"> <li>See above entries</li> <li>Area Plan, local policy, agreed task WMD Steering Committee</li> </ul>
<ul style="list-style-type: none"> <li>State Property</li> </ul>	<ul style="list-style-type: none"> <li>CHP (see waterways for F&amp;G )</li> </ul>	<ul style="list-style-type: none"> <li>Calif. State Emergency Plan-Terrorism Annex</li> </ul>
<ul style="list-style-type: none"> <li>Federal Property</li> </ul>	<ul style="list-style-type: none"> <li>FEMA</li> </ul>	<ul style="list-style-type: none"> <li>Federal Response Plan – TI-1</li> </ul>
<ul style="list-style-type: none"> <li>DOD site</li> </ul>	<ul style="list-style-type: none"> <li>Military owning site or weapon</li> </ul>	<ul style="list-style-type: none"> <li>Calif. State Emergency Plan-Terrorism Annex</li> </ul>

<b>AGRICULTURAL INCIDENT</b>		
<ul style="list-style-type: none"> <li>• Exotic Newcastle Disease</li> </ul>		<ul style="list-style-type: none"> <li>• CDFC</li> <li>• USDA</li> </ul>
<ul style="list-style-type: none"> <li>•</li> </ul>		<ul style="list-style-type: none"> <li>•</li> </ul>
<ul style="list-style-type: none"> <li>•</li> </ul>		<ul style="list-style-type: none"> <li>•</li> </ul>



**AGENCY FUNCTIONAL RESPONSIBILITY - General Hazardous Material**  
 (Based on regulation, statute, ordinance, MOU, local policy)

TASK ASSIGNMENT	Lead Support	ON-HIGHWAY	ON-ROADWAY	OFF-ROADWAY		LANDS OF STATE	WATERS OF STATE
				INCORPORATED	UNINCORPORATED		
ENVIRONMENTAL GROUP • Contain • Clean-up	<b>L</b>	SJC Environmental Health [H&S§101475]	SJC Environmental Health [H&S§101475]	SJC Environmental Health [H&S§101475]	SJC Environmental Health [H&S§101475]		RWQCB [Water Code §13307]
	<b>L</b>	CALTRANS	Public Works	Property owner	Property owner		DFG – Marine waters oil spills only [CGC§8670.7]
	<b>L</b>						DFG – Petroleum products only [F&G Code §5655]
	<b>L</b>						USCG – Marine facility oil spill [CGC §8670.27]
	<b>S</b>			SJC OES		SJC OES	
INVESTIGATION GROUP	<b>L</b>	CHP [CVC §2454]	Investigating law enforcement agency	Investigating law enforcement agency	Sheriff		RWQCB [Water Code §13163, 13307]
	<b>S</b>			Arson Investigator (PC 830.37)			DWR [Water Code §226(a)]
Security Group • Close area • Secure	<b>L</b>	Peace Officer & local health officer [§409.5PC]	Peace Officer & local health officer [§409.5PC]	Peace Officer & local health officer [§409.5PC]	Peace Officer & local health officer [§409.5PC]	Peace Officer [§409.5PC]	Peace Officer Sheriff Boating & Safety [§409.5PC]
	<b>S</b>	SJC Environmental Health [H&S §101475, 25359]	SJC Environmental Health [H&S §101040, 25359]	SJC Environmental Health [H&S §101040, 25359]	SJC Environmental Health [H&S §101040, 25359]		SJC Environmental Health [H&S §101040, 25359]
	<b>S</b>	CALTRANS	Public Works	Public Works	Public Works		
	<b>L</b>						USCG – Marine Waters
• Secure Airspace	<b>S</b>	Federal Aviation [FAR §91.137]					
EVACUATION GROUP	<b>L</b>	CHP	CHP-unincorporated City Police - incorporated	City Police	Sheriff		
FIRE CONTROL GROUP	<b>L</b>	Local Fire dept./ district	Local Fire dept./ district	Local Fire dept./ district	Local Fire dept./ district (Except unprotected area)	CDF	
HAZ MAT GROUP	<b>L</b>	CALTRANS	CALTRANS	Joint Team Agency	OES	CDF	
	<b>S</b>	Joint Team Agency	Joint Team Agency		Joint Team Agency	Joint Team Agency	Joint Team Agency

# USCG/EPA BOUNDARY

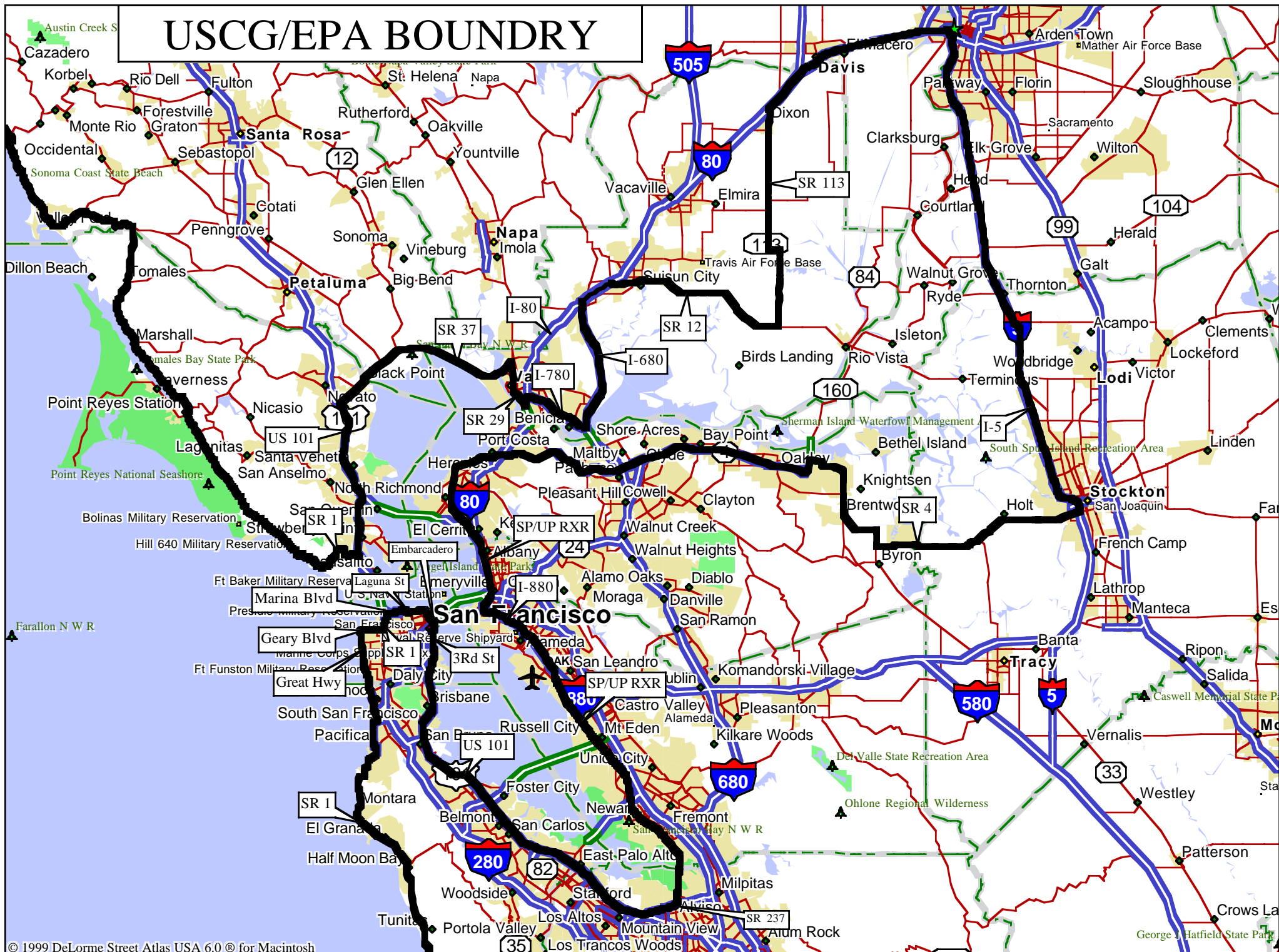

**SAN JOAQUIN OPERATIONAL AREA  
TRAINING SCHEDULE**

TYPE	INTERVAL	WHO	REFERENCE
<b>EQUIPMENT</b>			
Mask “fit-test”	Annual	Any user	Title 8, Subchapter 7, Group 16, Article 107, §5144
<b>FIRST RESPONDER</b>			
SEMS Orientation	Once	All responders	§8607, Article 9.5, Chapter 7, Division 2, Title 2, CGC
ICS Minimum I-100		Level as needed	
Awareness	Once	Support agencies; e.g. pw, utility	
Operational	Once & refresher	Hospital Skilled Support Personnel	29CFR 1910.120(q)(11) OSHA §3152
Operational	Once & refresher	All first responders Medical Personnel	§5192(q)(6), Article 109, Chapter 4, Division 1, Title 8, CCR §29 CFR 1919.120 (q)(6)
Technician	Once & refresher	Joint Team members	
Specialist	Once & refresher	Joint Team members	
Radiological Monitor	Basic once Annual refresher	Joint Team members	
Waste sites	Once	Any responder	§5192(1)(7) and (6), Article 109, Chapter 4, Division 1, Title 8, CCR and RCRA
		Hospital - Decon staff	OSHA Directive Number: CPL 2-2.59A (page 28)
<b>EXERCISES</b>			
Orientation Seminar	Once	Business employees	§25500, Article 1, Chapter 6.95, Division 20, H&S
Drills	Tri-annual Bi-annual Several	Joint Team at businesses Hospitals Joint Team & hospitals	
Table-Top	Bi-annual Quarterly	Operational Area EOC Incident Command Team	
Functional	Annual	Operational Area EOC	
Full-scale	Every 3 years	Incident Command Teams	

## NOTIFICATION REQUIREMENTS

TYPE OF RELEASE	WHO	TO WHOM	TIME FRAME	STATUTE OR REGULATION
<b>In Excess of "Reportable Quantity" (RQ)</b>	Any person in charge of any facility, as soon as he has knowledge of any release  Except a "federally permitted" release  Continuous releases do not have to be continuously reported	National Response Center	Immediately	CERCLA §103 (b)  [40 CFR Part 302 contains RQ list]
<b>Hazardous Substances</b> Released beyond the boundaries of a facility at which a hazardous material is released	Facility owner or operator who spills a harmful quantity	National Response Center	Immediately	Federal Water Pollution Control Act §311  CERCLA §103 (b)
Any release or threatened release, except transporting on a highway	The handler or any employee, authorized rep, agent, or designee	9-1-1  Calif. OES  Administering Agency	Immediately	H&S §25507 (a)
Highway transportation release	Any person who dumps, spills or causes the release	CHP, or agency with traffic jurisdiction	Immediately	CVC §23112
Within 1/2 mile of school	Emergency rescue personnel	Superintendent of school district	Immediately	H&S §25507.10
<b>Oil Spills</b>				
<b>State waters</b> Causes or permits any oil or petroleum product to be discharged in or on any waters of the state, or deposited where is, or probably will be discharged in or on any waters of the state	Any person  any local or state agency responding to a spill of oil	California OES  California OES	Immediately  Immediately	Water Code §13272 (a)  CGC §8670.26
<b>Marine waters</b> ≥ 42 gal	Any person	Nat'l. Response Center  Port of Stockton California OES		CGC §8670.25.5  Not required, agreed action H&S §25270.8
<b>Tank facility</b> Spill or release of one barrel (42 gallons) or more of petroleum	Owner or operator	Administrating Agency		
<b>Navigable water</b> "Harmful Quantities" - all discharges which "violate applicable water quality standards or cause a film or sheen upon the surface of the	Owner or operator as the source from which the discharge originates	US Coast Guard	Immediately	Federal Water Pollution Control Act §311

water”		EPA (can be through National Response Center)		33 CFR §153.203; 40 CFR §110.9
<b>Hazardous Waste Discharge</b>	Designated government employee within their jurisdictional boundary	Local health or Board of Supervisors	Within 72 hrs	H&S §25180.7
<b>Motor Vehicle fluids</b> - >40 gallons - -On roadway with health threat - Off roadway - Soil contamination - Health threat - Water threat	Responding agency	SJ Environmental Health	Immediately	Policy Statement

04/11/03

## **Appendix Q**

### **Emergency Flood Fight Materials and Equipment Inventory List**

## FLOOD FIGHT MATERIALS AND EQUIPMENT INVENTORY LIST

Location	Item	Quantity
	<b><u>Flood Fight Material/Equipment List</u></b>	
	Fill/Repair Material	
	Sandbags	
	Plastic Sheeting	
	Wood Stakes	
	Bailing Twine	
	Tie Down Buttons	
	Geotextile Fabric	
	<b><u>Patrolling</u></b>	
	Digital Camera	
	Batteries	
	Lighting (Flash Light, Flood Light)	
	Batteries	
	Lath (Bundle of 50)	
	Survey Ribbon	
	Permeant Ink Markers	
	Patrol Log	
	Measuring Tape (100')	
	<b><u>Tools</u></b>	
	Shovels	
	Sledge Hammer	
	Multi-Purpose Lineman Pliers	
	Pulaski	
	McLeod	
	Loppers	
	<b><u>Safety</u></b>	
	Rain Gear	
	Rubber Boots	
	Hard Hat	
	Safety Glasses	
	Gloves	
	Boots	
	Personal Flotation Device (PFD)	
	Personal Safety Light	
	Warm Clothing	
	First Aid Kit	